

# WASHERS, SHOULDER WASHERS & SCREW INSULATORS

## SECTION IV

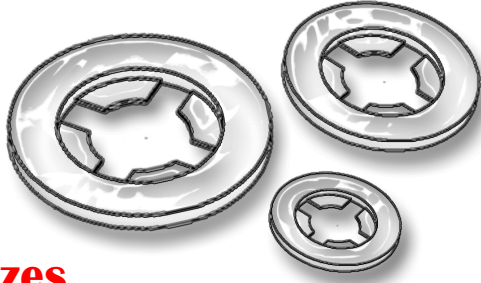

### New Sizes

Similar to our standard flat washers, but with a specially configured I.D. designed to grip the outside of the screw shank. The washer slides on the screw easily, but is retained on the screw. For use in applications requiring pre-assembly of the screw and washer, to reduce final assembly cost. Other sizes will be tooled on request.

## NYLON RETAINING WASHERS

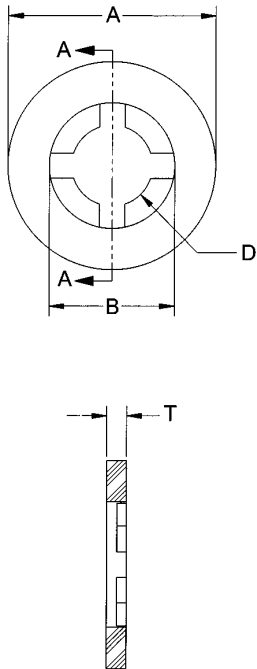

ITEM NUMBER	DESCRIPTION	A	B	D	T
16FWRT002032	FWRT 2-032 13/64	(5,16)	.115 (2,92)	.078 (1,98)	.032 (0,81)
16FWRT002062	FWRT 2-062 13/64	(5,16)	.115 (2,92)	.078 (1,98)	.062 (1,58)
16FWRT004032	FWRT 4-032 17/64	(6,75)	.156 (3,96)	.102 (2,59)	.032 (0,81)
16FWRT004062	FWRT 4-062 17/64	(6,75)	.156 (3,96)	.102 (2,59)	.062 (1,58)
16FWRT004125	FWRT 4-125 17/64	(6,75)	.156 (3,96)	.102 (2,59)	.125 (3,18)
16FWRT006032	FWRT 6-032 21/64	(8,33)	.198 (5,03)	.128 (3,25)	.032 (0,81)
16FWRT006062	FWRT 6-062 21/64	(8,33)	.198 (5,03)	.128 (3,25)	.062 (1,58)
16FWRT008032	FWRT 8-032 25/64	(9,92)	.235 (5,97)	.152 (3,86)	.032 (0,81)
16FWRT008045	FWRT 8-045	.453 (11,51)	.218 (5,54)	.135 (3,43)	.045 (1,14)
16FWRT008062	FWRT 8-062 25/64	(9,92)	.235 (5,97)	.152 (3,86)	.062 (1,58)
16FWRT010032	FWRT 10-032 29/64	(11,51)	.277 (7,04)	.177 (4,50)	.032 (0,81)
16FWRT010062	FWRT 10-062 29/64	(11,51)	.277 (7,04)	.177 (4,50)	.062 (1,58)
16FWRT010062A	FWRT 10-062A	1/2 (12,70)	.277 (7,04)	.177 (4,50)	.062 (1,58)
16FWRT250032	FWRT 250-032 19/32	(15,08)	.375 (9,53)	.234 (5,94)	.032 (0,81)
16FWRT250032A	FWRT 250-032A	.500 (12,70)	.344 (8,74)	.234 (5,94)	.032 (0,81)
16FWRT250062	FWRT 250-062 19/32	(15,08)	.375 (9,53)	.234 (5,94)	.062 (1,58)
16FWRT312032	FWRT 312-032 47/64	(18,65)	.470 (11,94)	.292 (7,42)	.032 (0,81)
16FWRT312062	FWRT 312-062 47/64	(18,65)	.470 (11,94)	.292 (7,42)	.062 (1,58)
16FWRT375032	FWRT 375-032 57/64	(22,62)	.564 (14,33)	.350 (8,89)	.032 (0,81)
16FWRT375062	FWRT 375-062 57/64	(22,62)	.564 (14,33)	.350 (8,89)	.062 (1,58)
16FWRT375062A	FWRT 375-062A	1.260 (32,00)	.563 (14,30)	.350 (8,89)	.062 (1,57)
16FWRT437032	FWRT 437-032 1-1/32	(26,19)	.570 (14,48)	.410 (10,41)	.032 (0,81)
16FWRT437062	FWRT 437-062 1-1/32	(26,19)	.570 (14,48)	.410 (10,41)	.062 (1,58)
16FWRT500032	FWRT 500-032 1-1/8	(28,58)	.690 (17,53)	.468 (11,89)	.032 (0,81)
16FWRT500062	FWRT 500-062 1-1/8	(28,58)	.690 (17,53)	.468 (11,89)	.062 (1,58)
16FWRT875062	FWRT 875-062 1-11/32	(34,14)	.940 (23,88)	.825 (20,96)	.062 (1,58)
16FWRT999062	FWRT 999-062 1.385	(35,18)	1.070 (27,18)	.970 (24,64)	.062 (1,57)

## NYLON FINISHING WASHERS

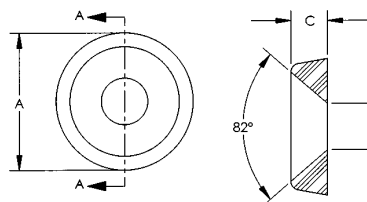
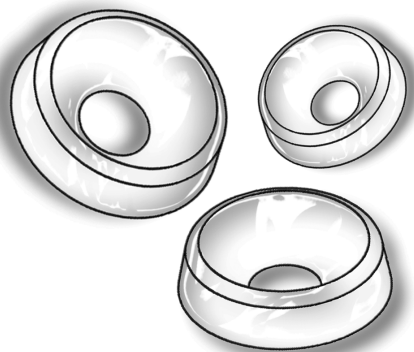

Available in natural or black nylon, these molded washers protect cabinets from scratching, cover misaligned holes, etc. May also be used as glides, bumpers, feet, and spacers.

ITEM NUMBER	DESCRIPTION	A	B	C
11SFW0006	SFW 6	.437 (11,10)	.143 (3,63)	.100 (2,54)
11SFW0008	SFW 8	.510 (12,95)	.171 (4,34)	.115 (2,92)
11SFW0010	SFW 10	.575 (14,61)	.196 (4,98)	.152 (3,86)
11SFW0012	SFW 12	.609 (15,47)	.225 (5,75)	.160 (4,06)
11SFW0025	SFW 25	.683 (17,35)	.260 (6,61)	.180 (4,57)

# WASHERS, SHOULDER WASHERS & SCREW INSULATORS

SECTION  
IV

We will also tool custom flatwashers for a nominal engineering charge .  
Size range up to 3" O.D. Minimum thickness 1/32"

**METRIC Sizes**  
**Also Available**  
Page 241

## NYLON STANDARD FLAT WASHERS

ITEM NUMBER	DESCRIPTION	A	B	T
16FW002032	FW 2-032	1/4 (6,35)	.090 (2,29)	.032 (0,81)
16FW002062	FW 2-062	1/4 (6,35)	.090 (2,29)	.062 (1,58)
16FW002093	FW 2-093	1/4 (6,35)	.090 (2,29)	.093 (2,36)
16FW002125	FW 2-125	1/4 (6,35)	.090 (2,29)	.125 (3,18)
16FW004032	FW 4-032	1/4 (6,35)	.115 (2,92)	.032 (0,81)
16FW004062	FW 4-062	1/4 (6,35)	.115 (2,92)	.062 (1,58)
16FW004093	FW 4-093	1/4 (6,35)	.115 (2,92)	.093 (2,36)
16FW004125	FW 4-125	1/4 (6,35)	.115 (2,92)	.125 (3,18)
16FW006032	FW 6-032	5/16 (7,94)	.140 (3,56)	.032 (0,81)
16FW006062	FW 6-062	5/16 (7,94)	.140 (3,56)	.062 (1,58)
16FW006093	FW 6-093	5/16 (7,94)	.140 (3,56)	.093 (2,36)
16FW006125	FW 6-125	5/16 (7,94)	.140 (3,56)	.125 (3,18)
16FW008032	FW 8-032	3/8 (9,53)	.171 (4,34)	.032 (0,81)
16FW008062	FW 8-062	3/8 (9,53)	.171 (4,34)	.062 (1,58)
16FW008093	FW 8-093	3/8 (9,53)	.171 (4,34)	.093 (2,36)
16FW008125	FW 8-125	3/8 (9,53)	.171 (4,34)	.125 (3,18)
16FW010032	FW 10-032	3/8 (9,53)	.194 (4,93)	.032 (0,81)
16FW010062	FW 10-062	3/8 (9,53)	.194 (4,93)	.062 (1,58)
16FW010093	FW 10-093	3/8 (9,53)	.194 (4,93)	.093 (2,36)
16FW010125	FW 10-125	3/8 (9,53)	.194 (4,93)	.125 (3,18)
16FW250032	FW 250-032	1/2 (12,70)	.257 (6,53)	.032 (0,81)
16FW250062	FW 250-062	1/2 (12,70)	.257 (6,53)	.062 (1,58)
16FW250093	FW 250-093	1/2 (12,70)	.257 (6,53)	.093 (2,36)
16FW250125	FW 250-125	1/2 (12,70)	.257 (6,53)	.125 (3,18)
16FW312032	FW 312-032	1/2 (12,70)	.317 (8,05)	.032 (0,81)
16FW312062	FW 312-062	1/2 (12,70)	.317 (8,05)	.062 (1,58)
16FW312093	FW 312-093	1/2 (12,70)	.317 (8,05)	.093 (2,36)
16FW312125	FW 312-125	1/2 (12,70)	.317 (8,05)	.125 (3,18)
16FW375032	FW 375-032	5/8 (15,88)	.375 (9,53)	.032 (0,81)
16FW375062	FW 375-062	5/8 (15,88)	.380 (9,65)	.062 (1,58)
16FW375093	FW 375-093	5/8 (15,88)	.380 (9,65)	.093 (2,36)
16FW375125	FW 375-125	5/8 (15,88)	.380 (9,65)	.125 (3,18)
16FW437032	FW 437-032	3/4 (19,05)	.443 (11,25)	.032 (0,81)
16FW437062	FW 437-062	3/4 (19,05)	.443 (11,25)	.062 (1,58)
16FW437093	FW 437-093	3/4 (19,05)	.443 (11,25)	.093 (2,36)
16FW437125	FW 437-125	3/4 (19,05)	.443 (11,25)	.125 (3,18)
16FW500032	FW 500-032	3/4 (19,05)	.505 (12,83)	.032 (0,81)
16FW500062	FW 500-062	3/4 (19,05)	.505 (12,83)	.062 (1,58)
16FW500093	FW 500-093	3/4 (19,05)	.505 (12,83)	.093 (2,36)
16FW500125	FW 500-125	3/4 (19,05)	.505 (12,83)	.125 (3,18)

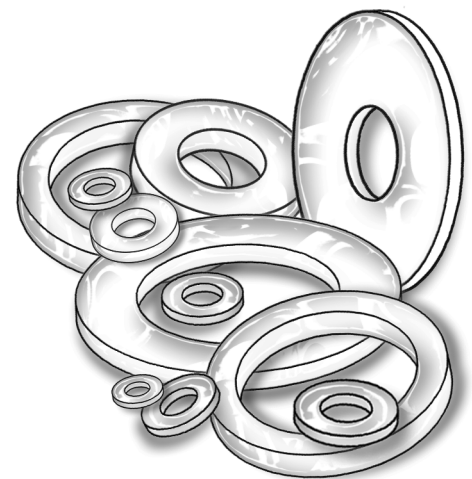
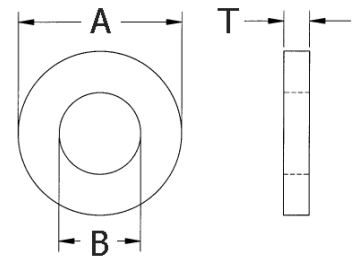

# WASHERS, SHOULDER WASHERS & SCREW INSULATORS

## SECTION IV

### New Sizes

### NYLON SPECIAL FLAT WASHERS

ITEM NUMBER	DESCRIPTION	A	B	T
17W00850	W 850	.085 (2,16)	.032 (0,81)	.062 (1,57)
17W00901	W 901	.090 (2,29)	.031 (0,79)	.031 (0,79)
17W01001	W 1001	.100 (2,54)	.035 (0,89)	.020 (0,51)
17W01011	W 1011	.125 (3,18)	.032 (0,81)	.060 (1,57)
17W01012	W 1012	.120 (3,05)	.063 (1,60)	.180 (4,57)
17W01013	W 1013	.120 (3,05)	.045 (1,14)	.130 (3,30)
17W01014	W 1014	.120 (3,05)	.055 (1,40)	.080 (2,03)
17W01015	W 1015	.120 (3,05)	.090 (2,29)	.180 (4,57)
17W01045	W 1045	.156 (3,96)	.031 (0,79)	.062 (1,57)
17W01381	W 1381	.138 (3,51)	.040 (1,02)	.033 (0,84)
17W01560	W 1560	.156 (3,96)	.050 (2,00)	.200 (5,08)
17W01561	W 1561	.156 (3,96)	.085 (2,16)	.200 (5,08)
17W01566	W 1566	.156 (3,96)	.076 (1,93)	.062 (1,57)
17W01581	W 1581	.158 (4,01)	.110 (2,79)	.070 (1,79)
17W01701	W 1701	.170 (4,32)	.038 (0,97)	.060 (1,52)
17W01702	W 1702	.182 (4,62)	.120 (3,05)	.125 (3,17)
17W01784	W 1784	.178 (4,52)	.098 (2,49)	.045 (1,14)
17W01791	W 1791	.179 (4,55)	.065 (1,65)	.078 (1,98)
17W01802	W 1802	.180 (4,57)	.139 (3,53)	.064 (1,63)
17W01803	W 1803	.186 (4,72)	.098 (2,49)	.030 (1,02)
17W01804	W 1804	.187 (4,75)	.120 (3,05)	.060 (1,52)
17W01805	W 1805	.187 (4,75)	.086 (2,18)	.130 (3,30)
17W01806	W 1806	.187 (4,75)	.145 (3,68)	.050 (1,27)
17W01807	W 1807	.187 (4,75)	.120 (3,05)	.032 (0,81)
17W01809	W 1809	.187 (4,75)	.141 (3,58)	.125 (3,18)
17W01811	W 1811	.187 (4,75)	.115 (2,92)	.165 (4,19)
17W01815	W 1815	.188 (4,78)	.094 (2,39)	.020 (0,51)
17W01825	W 1825	.196 (4,98)	.085 (2,16)	.031 (0,79)
17W01870	W 1870	.187 (4,75)	.120 (3,05)	.062 (1,57)
17W01871	W 1871	.185 (4,70)	.051 (1,30)	.132 (3,35)
17W01872	W 1872	.187 (4,75)	.091 (2,31)	.080 (2,03)
17W01875	W 1875	.187 (4,75)	.130 (3,30)	.150 (3,81)
17W01900	W 1900	.199 (5,05)	.115 (2,95)	.050 (1,27)
17W01906	W 1906	.206 (5,23)	.112 (2,84)	.053 (1,35)
17W01910	W 1910	.190 (4,83)	.120 (3,05)	.100 (2,54)
17W01950	W 1950	.197 (5,00)	.115 (2,92)	.030 (0,76)
17W01970	W 1970	.197 (5,00)	.100 (2,54)	.156 (3,96)
17W01971	W 1971	.197 (5,00)	.067 (1,70)	.154 (3,91)
17W01994	W 1994	.199 (5,05)	.125 (3,18)	.045 (1,14)
17W02181	W 2181	.218 (5,54)	.120 (3,05)	.037 (0,94)
17W02190	W 2190	.220 (5,59)	.104 (2,64)	.031 (0,79)
17W02191	W 2191	.219 (5,56)	.094 (2,39)	.100 (2,54)
17W02192	W 2192	.228 (5,79)	.122 (3,10)	.093 (2,36)
17W02245	W 2245	.225 (5,72)	.150 (3,81)	.045 (1,14)
17W02251	W 2251	.225 (5,72)	.125 (3,18)	.100 (2,54)
17W02252	W 2252	.225 (5,72)	.150 (3,81)	.090 (2,29)
17W02349	W 2349	.234 (5,94)	.141 (3,58)	.095 (2,41)

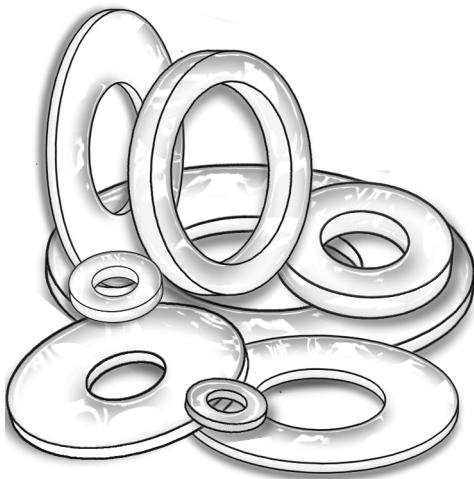
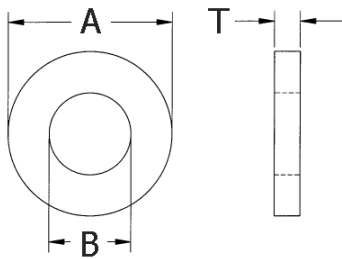

## New Sizes

### NYLON SPECIAL FLAT WASHERS

ITEM NUMBER	DESCRIPTION	A		B		T	
17W02350	W 2350	.235	(5,97)	.125	(3,18)	.040	(1,02)
17W02351	W 2351	.236	(5,99)	.126	(3,20)	.079	(2,01)
17W02401	W 2401	.240	(6,10)	.113	(2,87)	.040	(1,02)
17W02450	W 2450	.245	(6,22)	.195	(4,95)	.125	(3,18)
17W02451	W 2451	.245	(6,22)	.128	(3,25)	.093	(2,36)
17W02460	W 2460	.246	(6,25)	.171	(4,34)	.100	(2,54)
17W02500	W 2500	.250	(6,35)	.120	(3,05)	.140	(3,56)
17W02501	W 2501	.250	(6,35)	.160	(4,07)	.062	(1,57)
17W02502	W 2502	.250	(6,35)	.126	(3,20)	.025	(0,64)
17W02503	W 2503	.250	(6,35)	.090	(2,29)	.055	(1,40)
17W02504	W 2504	.250	(6,35)	.141	(3,58)	.062	(1,57)
17W02505	W 2505	.260	(6,60)	.140	(3,56)	.080	(2,03)
17W02506	W 2506	.250	(6,35)	.125	(3,18)	.095	(2,41)
17W02507	W 2507	.250	(6,35)	.140	(3,56)	.094	(2,39)
17W02508	W 2508	.250	(6,35)	.125	(3,18)	.062	(1,57)
17W02509	W 2509	.250	(6,35)	.171	(4,34)	.100	(2,54)
17W02510	W 2510	.250	(6,35)	.187	(4,75)	.130	(3,30)
17W02511	W 2511	.250	(6,35)	.142	(3,61)	.110	(2,79)
17W02512	W 2512	.250	(6,35)	.147	(3,73)	.125	(3,18)
17W02513	W 2513	.250	(6,35)	.143	(3,63)	.082	(2,08)
17W02514	W 2514	.250	(6,35)	.166	(4,22)	.082	(2,08)
17W02515	W 2515	.250	(6,35)	.140	(3,56)	.150	(3,81)
17W02516	W 2516	.251	(6,38)	.151	(3,84)	.035	(0,88)
17W02517	W 2517	.250	(6,35)	.156	(3,96)	.100	(2,54)
17W02518	W 2518	.250	(6,35)	.125	(3,18)	.150	(3,81)
17W02519	W 2519	.251	(6,38)	.155	(3,94)	.077	(1,96)
17W02520	W 2520	.250	(6,35)	.166	(4,22)	.061	(1,55)
17W02564	W 2564	.256	(6,50)	.187	(4,75)	.045	(1,14)
17W02591	W 2591	.259	(6,58)	.081	(2,06)	.062	(1,57)
17W02595	W 2595	.295	(7,49)	.135	(3,43)	.127	(3,23)
17W02751	W 2751	.275	(6,99)	.120	(3,05)	.062	(1,57)
17W02752	W 2752	.270	(6,86)	.207	(5,26)	.05	(1,27)
17W02781	W 2781	.280	(7,11)	.210	(5,33)	.125	(3,18)
17W02801	W 2801	.280	(7,11)	.120	(3,05)	.145	(3,68)
17W02810	W 2810	.280	(7,11)	.150	(3,81)	.108	(2,74)
17W02811	W 2811	.288	(7,32)	.120	(3,05)	.040	(1,02)
17W02812	W 2812	.290	(7,38)	.115	(2,92)	.047	(1,19)
17W02813	W 2813	.280	(7,11)	.120	(3,05)	.030	(0,76)
17W02814	W 2814	.281	(7,14)	.120	(3,05)	.020	(0,51)
17W02815	W 2815	.281	(7,14)	.120	(3,05)	.040	(1,02)
17W02816	W 2816	.281	(7,14)	.120	(3,05)	.060	(1,52)
17W02817	W 2817	.280	(7,11)	.155	(3,94)	.160	(4,06)
17W02818	W 2818	.281	(7,14)	.140	(3,56)	.020	(0,51)
17W02819	W 2819	.281	(7,14)	.107	(2,71)	.020	(0,51)
17W02851	W 2851	.285	(7,24)	.130	(3,30)	.060	(1,52)
17W02852	W 2852	.285	(7,24)	.160	(4,06)	.032	(0,81)
17W02853	W 2853	.280	(7,11)	.200	(5,08)	.093	(2,36)

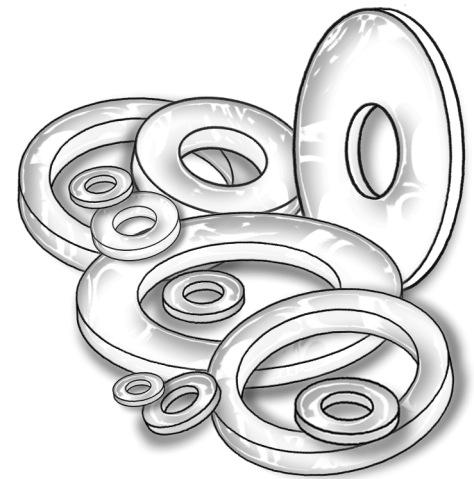
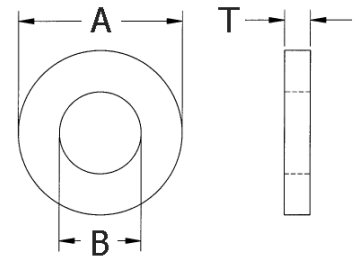

# WASHERS, SHOULDER WASHERS & SCREW INSULATORS

SECTION  
IV

New Sizes

## NYLON SPECIAL FLAT WASHERS

ITEM NUMBER	DESCRIPTION	A		B		T	
17W02862	W 2862	.282	(7,16)	.190	(4,83)	.065	(1,65)
17W02951	W 2951	.295	(7,49)	.220	(5,59)	.127	(3,23)
17W02952	W 2952	.310	(7,87)	.138	(3,50)	.030	(0,76)
17W02953	W 2953	.310	(7,87)	.190	(4,83)	.032	(0,81)
17W02954	W 2954	.310	(7,87)	.185	(4,70)	.032	(0,81)
17W03070	W 3070	.307	(7,80)	.210	(5,33)	.125	(3,18)
17W03071	W 3071	.307	(7,80)	.144	(3,66)	.059	(1,50)
17W03101	W 3101	.310	(7,87)	.160	(4,06)	.060	(1,52)
17W03121	W 3121	.312	(7,92)	.187	(4,75)	.050	(1,27)
17W03122	W 3122	.312	(7,92)	.095	(2,41)	.062	(1,57)
17W03123	W 3123	.318	(8,08)	.130	(3,30)	.062	(1,57)
17W03124	W 3124	.312	(7,92)	.110	(2,79)	.125	(3,18)
17W03125	W 3125	.312	(7,92)	.062	(1,57)	.125	(3,18)
17W03126	W 3126	.312	(7,92)	.115	(2,92)	.140	(3,56)
17W03127	W 3127	.312	(7,92)	.140	(3,56)	.047	(1,19)
17W03128	W 3128	.320	(8,13)	.156	(3,96)	.031	(0,79)
17W03129	W 3129	.312	(7,92)	.228	(5,79)	.250	(6,35)
17W03130	W 3130	.312	(7,92)	.162	(4,11)	.062	(1,57)
17W03131	W 3131	.312	(7,92)	.150	(3,81)	.020	(0,51)
17W03132	W 3132	.312	(7,92)	.125	(3,18)	.032	(0,81)
17W03133	W 3133	.312	(7,92)	.262	(6,65)	.127	(3,23)
17W03134	W 3134	.312	(7,92)	.150	(3,81)	.030	(0,76)
17W03135	W 3135	.312	(7,92)	.192	(4,88)	.110	(2,79)
17W03136	W 3136	.313	(7,95)	.217	(5,51)	.125	(3,18)
17W03137	W 3137	.312	(7,92)	.150	(3,81)	.040	(1,02)
17W03138	W 3138	.312	(7,92)	.150	(3,81)	.050	(1,27)
17W03139	W 3139	.312	(7,92)	.150	(3,81)	.060	(1,52)
17W03140	W 3140	5/16	(7,94)	5/32	(3,96)	1/8	(3,18)
17W03141	W 3141	.314	(7,98)	.110	(2,79)	.062	(1,57)
17W03142	W 3142	.312	(7,92)	.260	(6,60)	.070	(1,78)
17W03143	W 3143	.316	(8,03)	.100	(2,54)	.033	(0,84)
17W03145	W 3145	.312	(7,92)	.063	(1,60)	.090	(2,29)
17W03146	W 3146	.312	(7,92)	.140	(3,56)	.020	(0,51)
17W03148	W 3148	.315	(8,00)	.125	(3,18)	.031	(0,79)
17W03150	W 3150	.315	(8,00)	.157	(3,98)	.197	(5,00)
17W03151	W 3151	.312	(7,92)	.260	(6,60)	.109	(2,77)
17W03221	W 3221	.322	(8,18)	.128	(3,25)	.062	(1,57)
17W03223	W 3223	.330	(8,38)	.189	(4,80)	.080	(2,03)
17W03280	W 3280	.329	(8,36)	.150	(3,81)	.060	(1,52)
17W03281	W 3281	.335	(8,51)	.280	(7,11)	.195	(4,95)
17W03351	W 3351	.335	(8,51)	.190	(4,83)	.032	(0,81)
17W03412	W 3412	.434	(11,02)	.190	(4,83)	1/8	(3,18)
17W03450	W 3450	.345	(8,76)	.218	(5,54)	.032	(0,81)
17W03480	W 3480	.348	(8,84)	.222	(5,64)	.081	(2,06)
17W03501	W 3501	.350	(8,89)	.240	(6,10)	.040	(1,02)
17W03505	W 3505	.355	(9,02)	.130	(3,30)	.062	(1,57)
17W03506	W 3506	.356	(9,04)	.179	(4,55)	.118	(3,00)

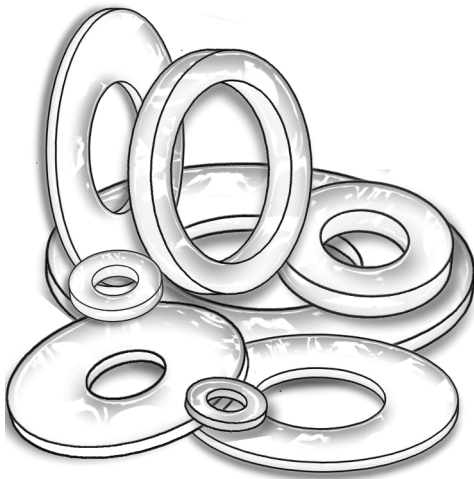
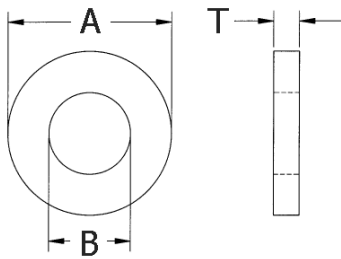

## New Sizes

### NYLON SPECIAL FLAT WASHERS

ITEM NUMBER	DESCRIPTION	A	B	T
17W03507	W 3507	.350 (8,89)	.190 (4,83)	.062 (1,57)
17W03510	W 3510	.350 (8,89)	.260 (6,60)	.062 (1,57)
17W03540	W 3540	.354 (8,99)	.169 (4,29)	.031 (0,79)
17W03541	W 3541	.353 (8,97)	.197 (5,00)	.157 (3,99)
17W03542	W 3542	.370 (9,40)	.192 (4,88)	.080 (2,03)
17W03601	W 3601	.374 (9,50)	.220 (5,59)	.062 (1,57)
17W03602	W 3602	.375 (9,53)	.173 (4,39)	.093 (2,36)
17W03630	W 3630	.370 (9,40)	.184 (4,67)	.047 (1,19)
17W03749	W 3749	.370 (9,40)	.192 (4,88)	.125 (3,18)
17W03750	W 3750	.375 (9,53)	.150 (3,81)	.030 (0,76)
17W03751	W 3751	.375 (9,53)	.172 (4,37)	.060 (1,52)
17W03752	W 3752	.375 (9,53)	.190 (4,83)	.065 (1,65)
17W03753	W 3753	.375 (9,53)	.131 (3,33)	.093 (2,36)
17W03754	W 3754	.375 (9,53)	.250 (6,35)	.093 (2,36)
17W03755	W 3755	.375 (9,53)	.218 (5,54)	.032 (0,81)
17W03756	W 3756	.375 (9,53)	.253 (6,43)	.084 (2,13)
17W03757	W 3757	.375 (9,53)	.141 (3,58)	.031 (0,79)
17W03758	W 3758	.375 (9,53)	.125 (3,18)	.040 (1,02)
17W03759	W 3759	.375 (9,53)	.094 (2,39)	.281 (7,14)
17W03760	W 3760	.375 (9,53)	.242 (6,15)	.062 (1,57)
17W03761	W 3761	.375 (9,53)	.210 (5,33)	.160 (4,06)
17W03762	W 3762	.375 (9,53)	.170 (4,32)	.040 (1,02)
17W03763	W 3763	.375 (9,53)	.170 (4,32)	.050 (1,27)
17W03764	W 3764	.375 (9,53)	.189 (4,80)	.031 (0,79)
17W03765	W 3765	.375 (9,53)	.140 (3,56)	.080 (2,03)
17W03766	W 3766	.375 (9,53)	.153 (3,89)	.063 (1,60)
17W03767	W 3767	.377 (9,58)	.221 (5,61)	.095 (2,41)
17W03768	W 3768	.375 (9,53)	.250 (6,35)	.150 (3,81)
17W03769	W 3769	.375 (9,53)	.210 (5,33)	.152 (3,86)
17W03770	W 3770	.375 (9,53)	.130 (3,30)	.030 (0,76)
17W03771	W 3771	.375 (9,53)	.255 (6,48)	.093 (2,36)
17W03772	W 3772	.375 (9,53)	.125 (3,18)	.072 (1,83)
17W03773	W 3773	1.000 (25,40)	.375 (9,53)	.312 (7,92)
17W03775	W 3775	.375 (9,53)	.135 (3,43)	.062 (1,57)
17W03776	W 3776	1.000 (25,40)	3/8" (9,53)	.295 (7,49)
17W03801	W 3801	.380 (9,65)	.200 (5,08)	.030 (0,76)
17W03802	W 3802	.380 (9,65)	.187 (4,75)	.155 (3,94)
17W03820	W 3820	.382 (9,70)	.255 (6,48)	.195 (4,95)
17W03900	W 3900	.390 (9,91)	.125 (3,18)	.063 (1,60)
17W03901	W 3901	.390 (9,91)	.200 (5,08)	.031 (0,79)
17W03902	W 3902	.389 (9,88)	.251 (6,37)	.125 (3,17)
17W03903	W 3903	.390 (9,91)	.328 (8,33)	.079 (2,01)
17W03904	W 3904	.400 (10,16)	.140 (3,56)	.062 (1,57)
17W04000	W 4000	.400 (10,16)	.200 (5,08)	.093 (2,36)
17W04060	W 4060	.405 (10,29)	.265 (6,73)	.125 (3,18)
17W04061	W 4061	.406 (10,31)	.234 (5,94)	.062 (1,57)
17W04062	W 4062	.406 (10,31)	.192 (4,88)	.062 (1,57)

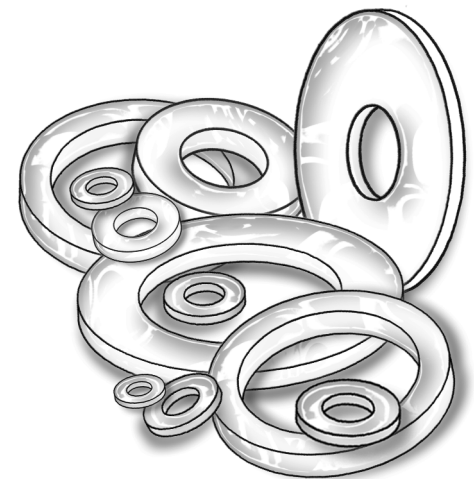
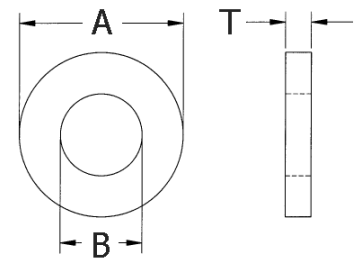

# WASHERS, SHOULDER WASHERS & SCREW INSULATORS

## SECTION IV

### New Sizes

### NYLON SPECIAL FLAT WASHERS

ITEM NUMBER	DESCRIPTION	A	B	T
17W04081	W 4081	.408 (10,36)	.177 (4,50)	.062 (1,57)
17W04150	W 4150	.415 (10,54)	.229 (5,82)	.102 (2,59)
17W04160	W 4160	.416 (10,57)	.272 (6,91)	.120 (3,05)
17W04250	W 4250	.425 (10,79)	.235 (5,97)	.130 (3,30)
17W04330	W 4330	.435 (11,05)	.209 (5,31)	.039 (0,99)
17W04331	W 4331	.433 (11,00)	.262 (6,65)	.126 (3,20)
17W04332	W 4332	.433 (11,00)	.275 (6,99)	.075 (1,91)
17W04333	W 4333	.433 (11,00)	.244 (6,20)	.054 (1,37)
17W04334	W 4334	.433 (11,00)	.276 (7,01)	.054 (1,37)
17W04348	W 4348	.435 (11,05)	.241 (6,12)	.094 (2,39)
17W04350	W 4350	.435 (11,05)	.202 (5,13)	.187 (4,75)
17W04351	W 4351	.435 (11,05)	.250 (6,35)	.094 (2,39)
17W04352	W 4352	.435 (11,05)	.196 (4,98)	.046 (1,17)
17W04353	W 4353	.438 (11,13)	.218 (5,54)	.156 (3,96)
17W04371	W 4371	.437 (11,10)	.200 (5,08)	.062 (1,57)
17W04372	W 4372	.437 (11,10)	.260 (6,60)	.047 (1,19)
17W04373	W 4373	.437 (11,10)	.195 (4,95)	.031 (0,79)
17W04374	W 4374	.437 (11,10)	.200 (5,08)	.115 (2,92)
17W04375	W 4375	.437 (11,10)	.200 (5,08)	.090 (2,29)
17W04376	W 4376	.437 (11,10)	.195 (4,95)	.020 (0,51)
17W04377	W 4377	.437 (11,10)	.195 (4,95)	.040 (1,02)
17W04378	W 4378	.437 (11,10)	.195 (4,95)	.050 (1,27)
17W04379	W 4379	.437 (11,10)	.195 (4,95)	.060 (1,27)
17W04380	W 4380	7/16 (11,10)	11/32 (8,74)	1/16 (0,81)
17W04386	W 4386	.438 (11,13)	.156 (3,96)	.062 (1,57)
17W04400	W 4400	.440 (11,18)	.156 (3,96)	.032 (0,81)
17W04401	W 4401	.445 (11,30)	.290 (7,37)	.033 (0,84)
17W04402	W 4402	.440 (11,18)	.187 (4,75)	.093 (2,36)
17W04403	W 4403	.440 (11,18)	.318 (8,08)	.031 (0,79)
17W04430	W 4430	.443 (11,25)	.253 (6,43)	.125 (3,18)
17W04450	W 4450	.450 (11,43)	.225 (5,72)	.048 (1,22)
17W04451	W 4451	.453 (11,51)	.375 (9,52)	.062 (1,57)
17W04452	W 4452	.453 (11,51)	.280 (7,11)	.030 (0,76)
17W04501	W 4501	.450 (11,43)	.200 (5,08)	.048 (1,22)
17W04502	W 4502	.465 (11,81)	.250 (6,35)	.015 (0,38)
17W04520	W 4520	.452 (11,48)	.349 (8,86)	.075 (1,91)
17W04601	W 4601	.460 (11,68)	.204 (5,18)	.031 (0,79)
17W04650	W 4650	.465 (11,81)	.330 (8,38)	.031 (0,79)
17W04651	W 4651	.486 (12,34)	.252 (6,40)	.069 (1,75)
17W04719	W 4719	.492 (12,50)	.209 (5,31)	.020 (0,51)
17W04720	W 4720	.472 (11,99)	.252 (6,40)	.059 (1,50)
17W04721	W 4721	.505 (12,83)	.375 (9,53)	.050 (1,27)
17W04722	W 4722	.472 (11,99)	.350 (8,89)	.110 (2,79)
17W04725	W 4725	.495 (12,57)	.310 (7,87)	.095 (2,41)
17W04900	W 4900	.490 (12,45)	.136 (3,45)	.055 (1,40)
17W04901	W 4901	.490 (12,45)	.375 (9,53)	.087 (2,21)
17W04950	W 4950	.490 (12,45)	.260 (6,60)	.245 (6,22)

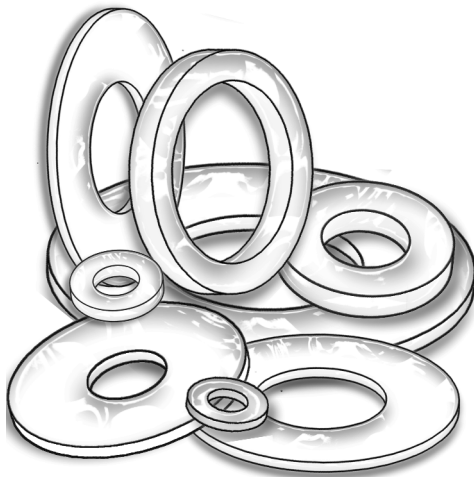
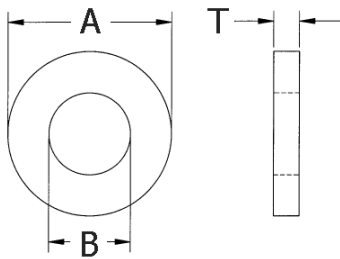

## New Sizes

### NYLON SPECIAL FLAT WASHERS

ITEM NUMBER	DESCRIPTION	A		B		T	
17W04951	W 4951	.500	(12,70)	.205	(5,21)	.125	(3,18)
17W04952	W 4952	.502	(12,72)	.101	(2,57)	.040	(1,02)
17W04953	W 4953	.500	(12,70)	.375	(9,53)	.032	(0,81)
17W04960	W 4960	.500	(12,70)	.225	(5,72)	.032	(0,81)
17W05000	W 5000	.500	(12,70)	.165	(4,19)	.075	(1,91)
17W05001	W 5001	.500	(12,70)	.343	(8,71)	.109	(2,77)
17W05002	W 5002	.500	(12,70)	.385	(9,78)	.160	(4,06)
17W05003	W 5003	.490	(12,45)	.281	(7,14)	.030	(0,76)
17W05004	W 5004	.500	(12,70)	.317	(8,05)	.032	(0,81)
17W05005	W 5005	.500	(12,70)	.375	(9,53)	.087	(2,21)
17W05006	W 5006	.500	(12,70)	.312	(7,92)	.156	(3,96)
17W05007	W 5007	.500	(12,70)	.250	(6,35)	.150	(3,81)
17W05008	W 5008	.505	(12,83)	.188	(4,78)	.032	(0,81)
17W05009	W 5009	.500	(12,70)	.255	(6,48)	.075	(1,91)
17W05010	W 5010	.500	(12,70)	.312	(7,92)	.125	(3,18)
17W05012	W 5012	.50	(12,70)	.125	(3,18)	.125	(3,18)
17W05013	W 5013	.500	(12,70)	.320	(8,13)	.170	(4,32)
17W05014	W 5014	.500	(12,70)	.140	(3,56)	.062	(1,57)
17W05015	W 5015	.500	(12,70)	.144	(3,66)	.125	(3,18)
17W05016	W 5016	.500	(12,70)	.219	(5,54)	.156	(3,90)
17W05017	W 5017	.50	(12,70)	.262	(6,65)	.15	(3,81)
17W05018	W 5018	.500	(12,70)	.187	(4,75)	.062	(1,57)
17W05019	W 5019	.500	(12,70)	.175	(4,45)	.062	(1,57)
17W05020	W 5020	.500	(12,70)	.320	(8,13)	.200	(5,08)
17W05021	W 5021	.505	(12,83)	.138	(3,51)	.080	(2,03)
17W05022	W 5022	.495	(12,57)	.147	(3,73)	.298	(7,57)
17W05023	W 5023	.500	(12,70)	.188	(4,78)	.062	(1,57)
17W05027	W 5027	1/2	(12,70)	.320	(8,13)	.250	(6,35)
17W05028	W 5028	.500	(12,70)	.320	(8,13)	.281	(7,14)
17W05081	W 5081	.500	(12,70)	.312	(7,92)	.096	(2,44)
17W05120	W 5120	.510	(12,95)	.193	(4,90)	.050	(1,27)
17W05121	W 5121	.512	(13,00)	.406	(10,31)	.089	(2,26)
17W05122	W 5122	.492	(12,50)	.287	(7,29)	.197	(5,00)
17W05129	W 5129	.518	(13,16)	.370	(9,40)	.038	(0,97)
17W05230	W 5230	.523	(13,28)	.463	(11,76)	.060	(1,52)
17W05231	W 5231	.538	(13,67)	.272	(6,91)	.047	(1,19)
17W05251	W 5251	.530	(13,46)	.375	(9,53)	.093	(2,36)
17W05252	W 5252	.528	(13,41)	.402	(10,21)	.039	(0,99)
17W05253	W 5253	.525	(13,34)	.475	(12,07)	.070	(1,78)
17W05254	W 5254	.525	(13,34)	.194	(4,93)	.032	(0,81)
17W05310	W 5310	.531	(13,49)	.313	(7,95)	.031	(0,79)
17W05400	W 5400	.540	(13,72)	.405	(10,29)	.112	(2,84)
17W05401	W 5401	.540	(13,72)	.382	(9,70)	.096	(2,44)
17W05421	W 5421	.542	(13,77)	.388	(9,86)	.220	(5,59)
17W05422	W 5422	.542	(13,77)	.404	(10,26)	.097	(2,46)
17W05423	W 5423	.542	(13,77)	.404	(10,26)	.110	(2,79)
17W05451	W 5451	.547	(13,89)	.363	(9,22)	.062	(1,57)

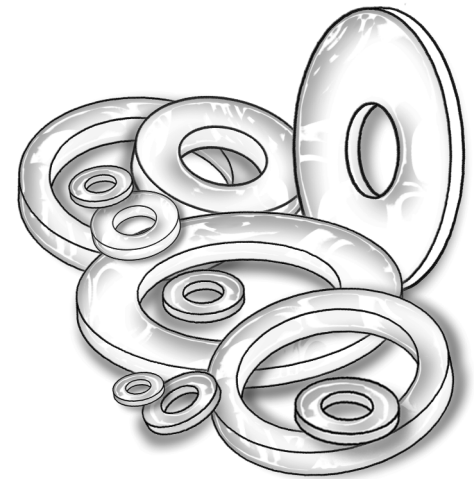
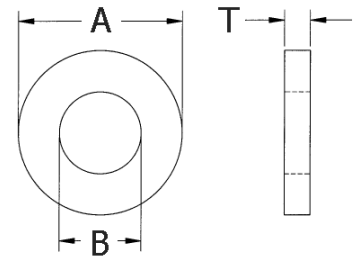



# WASHERS, SHOULDER WASHERS & SCREW INSULATORS

SECTION  
IV

New Sizes

## NYLON SPECIAL FLAT WASHERS

ITEM NUMBER	DESCRIPTION	A	B	T
17W05461	W 5461	.554 (14,07)	.481 (12,22)	.030 (0,76)
17W05510	W 5510	.551 (14,00)	.378 (9,60)	.063 (1,60)
17W05552	W 5552	.555 (14,10)	.255 (6,48)	.047 (1,19)
17W05553	W 5553	.555 (14,10)	.415 (10,54)	.060 (1,52)
17W05601	W 5601	.560 (14,22)	.265 (6,73)	.030 (0,76)
17W05602	W 5602	.560 (14,22)	.260 (6,60)	.125 (3,18)
17W05603	W 5603	.560 (14,22)	.320 (8,13)	.187 (4,75)
17W05605	W 5605	.560 (14,22)	.373 (9,47)	.031 (0,79)
17W05606	W 5606	.562 (14,27)	.265 (6,73)	.187 (4,75)
17W05607	W 5607	.560 (14,22)	.290 (7,37)	.062 (1,57)
17W05608	W 5608	.560 (14,22)	.315 (8,00)	.062 (1,57)
17W05620	W 5620	.562 (14,27)	.141 (3,58)	.062 (1,57)
17W05621	W 5621	.562 (14,27)	.250 (6,35)	.031 (0,79)
17W05622	W 5622	.562 (14,27)	.260 (6,60)	.062 (1,57)
17W05623	W 5623	.565 (14,35)	.203 (5,16)	.062 (1,57)
17W05624	W 5624	.562 (14,27)	.320 (8,13)	.020 (0,51)
17W05629	W 5629	.562 (14,27)	.328 (8,33)	.095 (2,41)
17W05630	W 5630	.565 (14,35)	.317 (8,05)	.095 (2,41)
17W05631	W 5631	.568 (14,43)	.253 (6,43)	.093 (2,36)
17W05650	W 5650	.565 (14,35)	.254 (6,45)	.094 (2,39)
17W05700	W 5700	.578 (14,68)	.307 (7,80)	.125 (3,18)
17W05751	W 5751	.575 (14,61)	.467 (11,86)	.090 (2,29)
17W05910	W 5910	.591 (15,01)	.256 (6,50)	.087 (2,21)
17W05980	W 5980	.598 (15,19)	.396 (10,03)	.175 (4,45)
17W05981	W 5981	.562 (14,27)	.320 (8,13)	.125 (3,18)
17W05982	W 5982	.590 (14,99)	.328 (8,33)	.147 (3,73)
17W05983	W 5983	.591 (15,01)	.374 (9,50)	.118 (3,00)
17W06001	W 6001	.600 (15,24)	.500 (12,70)	.120 (3,05)
17W06101	W 6101	.615 (15,62)	.406 (10,31)	.042 (1,07)
17W06140	W 6140	.614 (15,60)	.464 (11,79)	.110 (2,79)
17W06150	W 6150	.615 (15,62)	.260 (6,60)	.100 (2,54)
17W06151	W 6151	.625 (15,88)	.500 (12,70)	.132 (3,35)
17W06152	W 6152	.615 (15,62)	.340 (8,64)	.125 (3,18)
17W06153	W 6153	.625 (15,88)	.406 (10,31)	.120 (3,05)
17W06154	W 6154	.753 (19,13)	.605 (15,37)	.067 (1,70)
17W06155	W 6155	.615 (15,62)	.380 (9,65)	.122 (3,10)
17W06201	W 6201	.620 (15,75)	.265 (6,73)	.192 (4,89)
17W06203	W 6203	.620 (15,75)	.209 (5,31)	.187 (4,75)
17W06204	W 6204	.620 (15,75)	.350 (8,89)	.188 (4,78)
17W06205	W 6205	.625 (15,88)	.410 (10,41)	.033 (8,38)
17W06206	W 6206	.625 (15,88)	.260 (6,60)	.140 (3,56)
17W06221	W 6221	.622 (15,80)	.252 (6,40)	.060 (1,52)
17W06222	W 6222	.625 (15,88)	.250 (6,35)	.190 (4,83)
17W06240	W 6240	.625 (15,88)	.505 (12,83)	.092 (2,34)
17W06248	W 6248	.625 (15,88)	.330 (8,38)	.064 (1,63)
17W06249	W 6249	.625 (15,88)	.260 (6,60)	.180 (4,57)
17W06250	W 6250	.620 (15,75)	.165 (4,19)	.250 (6,35)

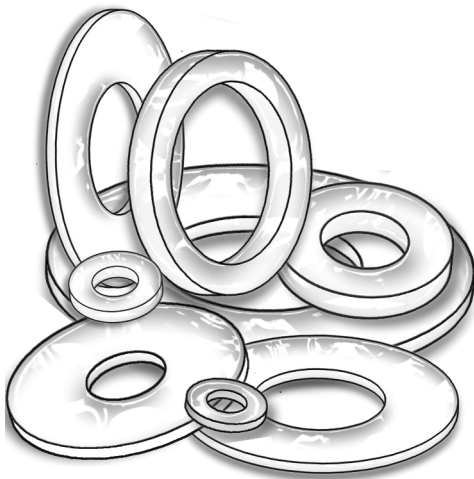
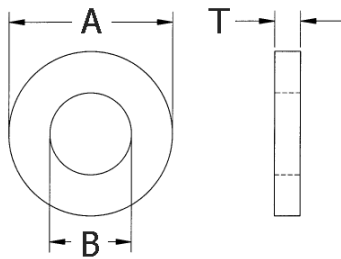

## New Sizes

### NYLON SPECIAL FLAT WASHERS

ITEM NUMBER	DESCRIPTION	A	B	T
17W06251*	W 6251	.620 (15,87)	.301 (7,64)	.039 (0,99)
17W06252	W 6252	.625 (15,88)	.194 (4,93)	.125 (3,18)
17W06253	W 6253	.625 (15,88)	.187 (4,75)	.062 (1,57)
17W06254	W 6254	.625 (15,88)	.218 (5,54)	.062 (1,57)
17W06255	W 6255	.625 (15,88)	.250 (6,35)	.062 (1,57)
17W06256	W 6256	.625 (15,88)	.437 (11,10)	.093 (2,36)
17W06257	W 6257	.625 (15,88)	.125 (3,18)	.062 (1,57)
17W06258	W 6258	.625 (15,88)	.218 (5,54)	.125 (3,18)
17W06259	W 6259	.625 (15,88)	.218 (5,54)	.500 (12,70)
17W06260	W 6260	.625 (15,88)	.218 (5,54)	.250 (6,35)
17W06261	W 6261	.625 (15,88)	.390 (9,91)	.265 (6,73)
17W06262	W 6262	.625 (15,88)	.257 (6,53)	.020 (0,51)
17W06263	W 6263	.625 (15,88)	.281 (7,14)	.110 (2,79)
17W06264	W 6264	.625 (15,88)	.315 (8,00)	.031 (0,79)
17W06265	W 6265	.625 (15,88)	.422 (10,72)	.203 (5,16)
17W06266	W 6266	.625 (15,88)	.321 (8,15)	.125 (3,18)
17W06267	W 6267	.625 (15,88)	.218 (5,54)	.031 (0,79)
17W06268	W 6268	.625 (15,88)	.437 (11,10)	.250 (6,35)
17W06269	W 6269	5/8 (15,87)	.281 (7,14)	.210 (5,33)
17W06270	W 6270	.618 (15,70)	.270 (6,86)	.220 (5,59)
17W06271	W 6271	.630 (16,00)	.327 (8,31)	.071 (1,80)
17W06272	W 6272	.625 (15,88)	.385 (9,78)	.185 (4,70)
17W06273	W 6273	.625 (15,88)	.312 (7,92)	.250 (6,35)
17W06274	W 6274	.625 (15,88)	.284 (7,21)	.062 (1,57)
17W06275	W 6275	.625 (15,88)	.292 (7,42)	.040 (1,02)
17W06276	W 6276	.630 (16,00)	.355 (9,02)	.040 (1,02)
17W06289	W 6289	.625 (15,88)	.265 (6,73)	.093 (2,36)
17W06302	W 6302	.630 (16,00)	.171 (4,34)	.060 (1,52)
17W06303	W 6303	.638 (16,20)	.283 (7,19)	.077 (1,96)
17W06304	W 6304	.629 (15,98)	.437 (11,10)	.125 (3,18)
17W06310	W 6310	.630 (16,00)	.280 (7,11)	.030 (0,76)
17W06365	W 6365	.636 (16,15)	.526 (13,36)	.098 (2,49)
17W06439	W 6439	.643 (16,33)	.510 (12,95)	.090 (2,29)
17W06440	W 6440	1.122 (28,50)	.644 (16,36)	.217 (5,51)
17W06500	W 6500	.650 (16,51)	.440 (11,18)	.125 (3,18)
17W06501	W 6501	1.190 (30,23)	.650 (16,51)	.090 (2,29)
17W06591	W 6591	.659 (16,74)	.468 (11,89)	.119 (3,02)
17W06620	W 6620	.662 (16,81)	.440 (11,18)	.122 (3,10)
17W06701	W 6701	.670 (17,02)	.448 (11,38)	.120 (3,05)
17W06711	W 6711	.671 (17,04)	.481 (12,22)	.031 (0,79)
17W06820	W 6820	.682 (17,32)	.170 (4,32)	.062 (1,57)
17W06830	W 6830	.683 (17,35)	.337 (8,56)	.063 (1,60)
17W06851	W 6851	.685 (17,40)	.260 (6,60)	.032 (0,81)
17W06855	W 6855	.685 (17,40)	.295 (7,49)	.062 (1,57)
17W06856	W 6856	.695 (17,65)	.388 (9,85)	.059 (1,50)
17W06867	W 6867	.687 (17,45)	.343 (8,71)	.031 (0,79)
17W06868	W 6868	.687 (17,45)	.260 (6,60)	.020 (0,51)

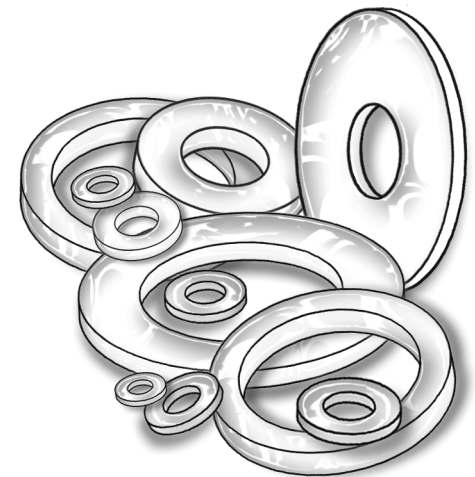
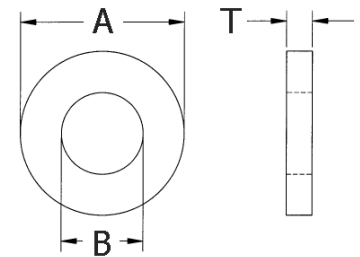

\* ID IS CHAMFERED



# WASHERS, SHOULDER WASHERS & SCREW INSULATORS

SECTION  
IV

New Sizes

## NYLON SPECIAL FLAT WASHERS

ITEM NUMBER	DESCRIPTION	A		B		T	
17W06869	W 6869	.687	(17,45)	.260	(6,60)	.050	(1,27)
17W06870	W 6870	.687	(17,45)	.344	(8,79)	.064	(1,63)
17W06871	W 6871	.687	(17,45)	.260	(6,60)	.060	(1,52)
17W06872	W 6872	.687	(17,45)	.260	(6,60)	.040	(1,02)
17W06873	W 6873	.687	(17,45)	.421	(10,69)	.031	(0,79)
17W06874	W 6874	.687	(17,45)	.421	(10,69)	.062	(1,57)
17W06875	W 6875	.692	(17,58)	.507	(12,88)	.042	(1,07)
17W06876	W 6876	.687	(17,45)	.568	(14,43)	.062	(1,57)
17W06877	W 6877	.680	(17,27)	.390	(9,91)	.125	(3,18)
17W06878	W 6878	.687	(17,45)	.156	(3,96)	.135	(3,43)
17W06879	W 6879	.687	(17,45)	.280	(7,11)	.031	(0,79)
17W06880	W 6880	.680	(17,27)	.318	(8,08)	.187	(4,75)
17W06881	W 6881	.688	(17,48)	.390	(9,91)	.031	(0,79)
17W06882	W 6882	.688	(17,48)	.318	(8,08)	.190	(4,83)
17W06883	W 6883	.689	(17,50)	.244	(6,20)	.236	(5,99)
17W06934	W 6934	.695	(17,65)	.082	(2,08)	.184	(4,67)
17W06935	W 6935	.690	(17,53)	.525	(13,34)	.250	(6,35)
17W07001	W 7001	.700	(17,78)	.565	(14,35)	.062	(1,57)
17W07002	W 7002	.700	(17,78)	.531	(13,49)	.093	(2,36)
17W07051	W 7051	.715	(18,16)	.570	(14,48)	.100	(2,54)
17W07090	W 7090	.709	(18,01)	.336	(8,53)	.079	(2,01)
17W07091	W 7091	.709	(18,01)	.461	(11,71)	.110	(2,79)
17W07092	W 7092	.697	(17,70)	.531	(13,49)	.158	(4,01)
17W07093	W 7093	.71	(18,03)	.49	(12,45)	.125	(3,17)
17W07120	W 7120	.712	(18,08)	.522	(13,30)	.062	(1,57)
17W07121	W 7121	.712	(18,08)	.312	(7,92)	.081	(2,06)
17W07130	W 7130	.713	(18,11)	.463	(11,76)	.065	(1,65)
17W07181	W 7181	.718	(18,24)	.526	(13,36)	.219	(5,56)
17W07182	W 7182	.718	(18,24)	.526	(13,36)	.281	(7,14)
17W07191	W 7191	.719	(18,26)	.250	(6,35)	.062	(1,57)
17W07192	W 7192	.719	(18,26)	.281	(7,14)	.062	(1,57)
17W07193	W 7193	.709	(18,01)	.248	(6,10)	.118	(3,00)
17W07301	W 7301	.720	(18,29)	.390	(9,91)	.300	(7,62)
17W07302	W 7302	.731	(18,57)	.266	(6,76)	.118	(3,00)
17W07381	W 7381	.740	(18,80)	.220	(5,59)	.120	(3,05)
17W07382	W 7382	.738	(18,75)	.522	(13,26)	.120	(3,05)
17W07401	W 7401	.740	(18,80)	.340	(8,64)	.062	(1,57)
17W07402	W 7402	.750	(19,05)	.375	(9,53)	.062	(1,57)
17W07403	W 7403	.748	(19,00)	.395	(10,03)	.093	(2,36)
17W07404	W 7404	.750	(19,05)	.440	(11,18)	.093	(2,36)
17W07405	W 7405	.750	(19,05)	.385	(9,78)	.045	(1,14)
17W07406	W 7406	.740	(18,80)	.516	(13,11)	.125	(3,18)
17W07420	W 7420	.742	(18,85)	.498	(12,65)	.119	(3,02)
17W07480	W 7480	.748	(19,00)	.403	(10,24)	.059	(1,50)
17W07491	W 7491	.750	(19,05)	.191	(4,85)	.100	(2,54)
17W07493	W 7493	.738	(18,75)	.220	(5,59)	.155	(3,94)

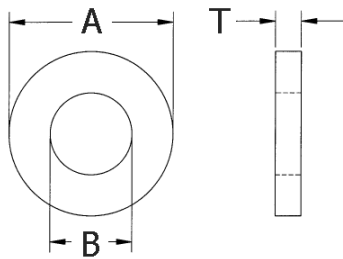

## New Sizes

### NYLON SPECIAL FLAT WASHERS

ITEM NUMBER	DESCRIPTION	A	B	T
17W07494	W 7494	.750 (19,05)	.257 (6,53)	.030 (0,76)
17W07500	W 7500	.750 (19,05)	.261 (6,63)	.095 (2,41)
17W07501	W 7501	.750 (19,05)	.187 (4,75)	.156 (3,96)
17W07502	W 7502	.735 (18,67)	.360 (9,14)	.160 (4,06)
17W07503	W 7503	.750 (19,05)	.323 (8,20)	.125 (3,18)
17W07504	W 7504	.738 (18,75)	.382 (9,70)	.160 (4,06)
17W07505	W 7505	.740 (18,79)	.531 (13,49)	.187 (4,75)
17W07506	W 7506	.750 (19,05)	.390 (9,91)	.062 (1,57)
17W07507	W 7507	.750 (19,05)	.352 (8,94)	.031 (0,79)
17W07508	W 7508	.750 (19,05)	.390 (9,91)	.050 (1,27)
17W07509	W 7509	.750 (19,05)	.390 (9,91)	.140 (3,56)
17W07510	W 7510	.750 (19,05)	.530 (13,46)	.230 (5,84)
17W07511	W 7511	.750 (19,05)	.625 (15,88)	.170 (4,32)
17W07512	W 7512	.750 (19,05)	.385 (9,78)	.200 (5,08)
17W07513	W 7513	.750 (19,05)	.317 (8,05)	.062 (1,57)
17W07514	W 7514	.750 (19,05)	.193 (4,90)	.040 (1,02)
17W07516	W 7516	.750 (19,05)	.382 (9,70)	.066 (1,68)
17W07517	W 7517	.750 (19,05)	.406 (10,31)	.032 (0,81)
17W07518	W 7518	.745 (18,92)	.443 (11,25)	.095 (2,41)
17W07519	W 7519	.750 (19,05)	.218 (5,54)	.187 (4,75)
17W07520	W 7520	.745 (18,92)	.260 (6,60)	.066 (1,68)
17W07521	W 7521	.750 (19,05)	.320 (8,13)	.250 (6,35)
17W07522	W 7522	.750 (19,05)	.406 (10,31)	.060 (1,52)
17W07523	W 7523	.745 (18,92)	.260 (6,60)	.125 (3,18)
17W07524	W 7524	.743 (18,87)	.516 (13,11)	.093 (2,36)
17W07525	W 7525	.750 (19,05)	.406 (10,31)	.200 (5,08)
17W07527	W 7527	.750 (19,05)	.375 (9,53)	.125 (3,18)
17W07528	W 7528	.750 (19,05)	.385 (9,78)	.025 (0,63)
17W07529	W 7529	.75 (19,05)	.31 (7,87)	.375 (9,53)
17W07530	W 7530	.750 (19,05)	.257 (6,53)	.062 (1,57)
17W07531	W 7531	.755 (19,18)	.558 (14,17)	.030 (0,76)
17W07532	W 7532	.750 (19,05)	.150 (3,81)	.055 (1,40)
17W07533	W 7533	.750 (19,05)	.47 (11,94)	.200 (5,08)
17W07534	W 7534	.685 (17,40)	.473 (12,01)	.190 (4,83)
17W07535	W 7535	.75 (19,05)	.30 (7,62)	.125 (3,17)
17W07536	W 7536	.754 (19,15)	.389 (9,88)	.075 (1,91)
17W07537	W 7537	.750 (19,05)	.437 (11,10)	.036 (0,91)
17W07539	W 7539	.962 (24,43)	.755 (19,18)	.101 (2,57)
17W07540	W 7540	.753 (19,13)	.605 (15,37)	.055 (1,40)
17W07541	W 7541	3/4" (19,05)	.257 (6,53)	.109 (2,77)
17W07542	W 7542	.755 (19,18)	.318 (8,08)	.100 (2,54)
17W07559	W 7559	.750 (19,05)	.380 (9,65)	.187 (4,75)
17W07560	W 7560	.756 (19,20)	.578 (14,68)	.110 (2,79)
17W07565	W 7565	.745 (18,92)	.509 (12,93)	.150 (3,81)
17W07566	W 7566	.750 (19,05)	.310 (7,87)	.170 (4,32)
17W07625	W 7625	.75 (19,05)	.274 (6,96)	.25 (6,35)

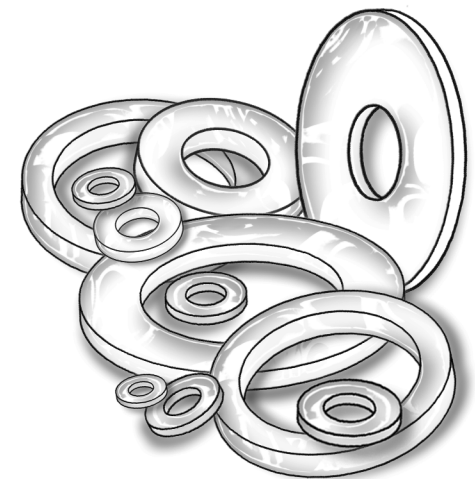
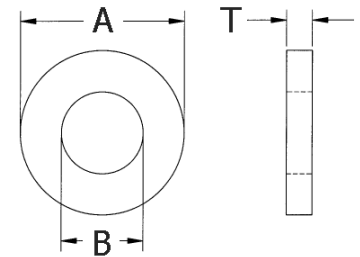

# WASHERS, SHOULDER WASHERS & SCREW INSULATORS

SECTION  
IV

New Sizes

## NYLON SPECIAL FLAT WASHERS

ITEM NUMBER	DESCRIPTION	A	B	T
17W07714	W 7714 3/4" (19,05)	.317 (8,05)	.040 (1,02)	
17W07716	W 7716 .750 (19,05)	.296 (7,52)	.032 (0,81)	
17W07717	W 7717 .750 (19,05)	.328 (8,33)	.032 (0,81)	
17W07718	W 7718 .757 (19,23)	.394 (10,01)	.125 (3,18)	
17W07719	W 7719 .748 (19,00)	.400 (10,16)	.089 (2,26)	
17W07720	W 7720 .753 (19,13)	.282 (7,16)	.123 (3,12)	
17W07721	W 7721 .740 (18,80)	.215 (5,46)	.095 (2,41)	
17W07722	W 7722 .750 (19,05)	.565 (14,35)	.125 (3,18)	
17W07750	W 7750 .775 (19,69)	.515 (13,08)	.250 (6,35)	
17W07751	W 7751 .775 (19,69)	.500 (12,70)	.120 (3,05)	
17W07752	W 7752 .775 (19,69)	.485 (12,32)	.150 (3,81)	
17W07811	W 7811 .781 (19,84)	.640 (16,26)	.031 (0,79)	
17W07820	W 7820 .782 (19,86)	.633 (16,08)	.125 (3,18)	
17W07821	W 7821 .778 (19,76)	.590 (14,99)	.032 (0,81)	
17W07850	W 7850 .785 (19,94)	.394 (10,01)	.080 (2,03)	
17W08049	W 8049 .805 (20,45)	.418 (10,62)	.062 (1,57)	
17W08050	W 8050 .805 (20,45)	.510 (12,95)	.220 (5,59)	
17W08051	W 8051 .805 (20,45)	.621 (15,77)	.125 (3,18)	
17W08070	W 8070 .807 (20,50)	.402 (10,21)	.065 (1,65)	
17W08090	W 8090 .809 (20,55)	.495 (12,57)	.059 (1,50)	
17W08100	W 8100 .810 (20,57)	.435 (11,05)	.060 (1,52)	
17W08110	W 8110 .817 (20,75)	.544 (13,82)	.140 (3,56)	
17W08121	W 8121 .812 (20,67)	.695 (17,65)	.093 (2,36)	
17W08122	W 8122 .812 (20,62)	.630 (16,00)	.100 (2,56)	
17W08123	W 8123 .812 (20,62)	.312 (7,92)	.125 (3,18)	
17W08125	W 8125 .812 (20,62)	.630 (16,00)	.220 (5,59)	
17W08126	W 8126 .812 (20,62)	.386 (9,80)	.187 (4,75)	
17W08251	W 8251 .825 (20,96)	.480 (12,19)	.100 (2,54)	
17W08252	W 8252 .825 (20,96)	.561 (14,25)	.145 (3,68)	
17W08400	W 8400 .840 (21,34)	.730 (18,54)	.125 (3,18)	
17W08430	W 8430 .844 (21,44)	.656 (16,66)	.060 (1,52)	
17W08431	W 8431 .845 (21,46)	.621 (15,77)	.101 (2,57)	
17W08452	W 8452 .825 (20,96)	.375 (9,53)	.100 (2,54)	
17W08650	W 8650 .865 (21,97)	.531 (13,49)	.200 (5,08)	
17W08651	W 8651 .865 (21,97)	.688 (17,48)	.155 (3,94)	
17W08652	W 8652 .875 (22,23)	.755 (19,18)	.125 (3,18)	
17W08660	W 8660 .866 (21,97)	.413 (10,49)	.098 (2,49)	
17W08661	W 8661 .876 (22,25)	.437 (11,10)	.502 (12,75)	
17W08711	W 8711 .871 (22,12)	.706 (17,93)	.111 (2,82)	
17W08751	W 8751 .875 (22,23)	.312 (7,92)	.125 (3,18)	
17W08752	W 8752 .875 (22,23)	.408 (10,36)	.060 (1,52)	
17W08753	W 8753 .875 (22,23)	.257 (6,53)	.031 (0,79)	
17W08754	W 8754 .885 (22,48)	.343 (8,71)	.062 (1,57)	
17W08755	W 8755 .855 (21,72)	.312 (7,92)	.125 (3,18)	
17W08756	W 8756 .875 (22,23)	.500 (12,70)	.125 (3,18)	
17W08757	W 8757 .875 (22,23)	.312 (7,92)	.187 (4,75)	
17W08758	W 8758 .865 (21,97)	.340 (8,64)	.187 (4,75)	

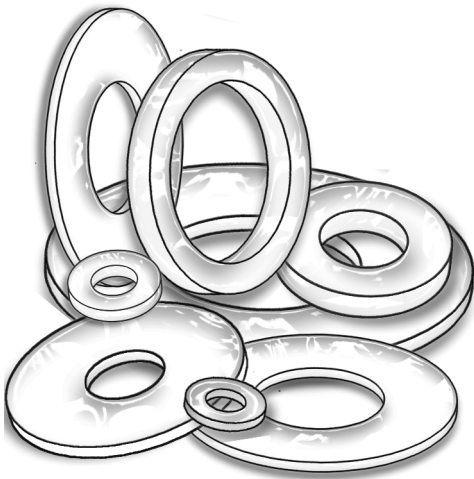
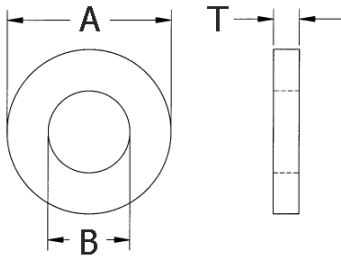

## New Sizes

### NYLON SPECIAL FLAT WASHERS

ITEM NUMBER	DESCRIPTION	A	B	T
17W08759	W 8759	.875 (22,23)	.377 (9,58)	.062 (1,57)
17W08760	W 8760	.875 (22,23)	.380 (9,65)	.093 (2,36)
17W08761	W 8761	.875 (22,23)	.390 (9,91)	.093 (2,36)
17W08762	W 8762	.875 (22,23)	.257 (6,53)	.062 (1,57)
17W08763	W 8763	.875 (22,23)	.627 (15,93)	.114 (2,90)
17W08764	W 8764	7/8 (22,23)	.265 (6,73)	.093 (2,36)
17W08765	W 8765	.870 (22,10)	.531 (13,49)	.187 (4,75)
17W08767	W 8767	.860 (21,84)	.397 (10,08)	.165 (4,19)
17W08768	W 8768	.885 (22,48)	.390 (9,91)	.094 (2,39)
17W08769	W 8769	.875 (22,23)	.750 (19,05)	.160 (4,06)
17W08800	W 8800	.880 (22,35)	.390 (9,91)	.062 (1,57)
17W08801	W 8801	.872 (22,15)	.315 (8,00)	.062 (1,57)
17W08803	W 8803	.882 (22,40)	.589 (14,96)	.085 (2,16)
17W08806	W 8806	.885 (22,48)	.385 (9,78)	.062 (1,57)
17W08810	W 8810	.880 (22,35)	.500 (12,70)	.065 (1,65)
17W08812	W 8812	.880 (22,86)	.385 (9,78)	.125 (3,18)
17W08901	W 8901	.890 (22,61)	.315 (8,00)	.215 (5,46)
17W08950	W 8950	.900 (22,86)	.255 (6,48)	.125 (3,18)
17W08951	W 8951	.890 (22,61)	.317 (8,05)	.245 (6,22)
17W09000	W 9000	.900 (22,86)	.375 (9,53)	.055 (1,40)
17W09001	W 9001	.900 (22,86)	.500 (12,70)	.075 (1,91)
17W09002	W 9002	.900 (22,86)	.515 (13,08)	.060 (1,52)
17W09260	W 9260	.926 (23,52)	.705 (17,91)	.124 (3,15)
17W09282	W 9282	.970 (24,64)	.230 (5,84)	.125 (3,18)
17W09283	W 9283	1.005 (25,53)	.406 (10,31)	.080 (2,03)
17W09290	W 9290	.929 (23,60)	.472 (11,99)	.126 (3,20)
17W09320	W 9320	.932 (23,67)	.381 (9,68)	.031 (0,79)
17W09350	W 9350	15/16 (23,81)	.380 (9,65)	.062 (1,57)
17W09371	W 9371	.937 (23,80)	.625 (15,88)	.093 (2,36)
17W09376	W 9376	.937 (23,80)	.583 (14,81)	.062 (1,57)
17W09378	W 9378	.937 (23,80)	.580 (14,73)	.082 (2,08)
17W09381	W 9381	.938 (23,83)	.453 (11,51)	.155 (3,94)
17W09400	W 9400	.944 (23,98)	.331 (8,41)	.098 (2,49)
17W09406	W 9406	.940 (23,88)	.506 (12,85)	.064 (1,63)
17W09571	W 9571	.957 (24,31)	.666 (16,92)	.139 (3,53)
17W09600	W 9600	.960 (24,38)	.692 (17,58)	.126 (3,20)
17W09806	W 9806	.980 (24,89)	.343 (8,71)	.065 (1,65)
17W09841	W 9841	.984 (24,99)	.406 (10,31)	.125 (3,18)
17W09851	W 9851	.983 (24,97)	.360 (9,14)	.120 (3,05)
17W09852	W 9852	.990 (25,15)	.416 (10,57)	.060 (1,52)
17W09853	W 9853	1.000 (25,40)	.781 (19,84)	.075 (1,91)
17W09854	W 9854	1.000 (25,40)	.333 (8,46)	.385 (9,78)
17W09855	W 9855	.990 (25,15)	.337 (8,56)	.292 (7,42)
17W09856	W 9856	1.000 (25,40)	.339 (8,61)	.154 (3,91)
17W09900	W 9900	1.000 (25,40)	.375 (9,53)	.062 (1,57)
17W09901	W 9901	1 (25,40)	.76 (19,30)	.062 (1,57)
17W09902	W 9902	1.003 (25,48)	.485 (12,32)	.173 (4,39)

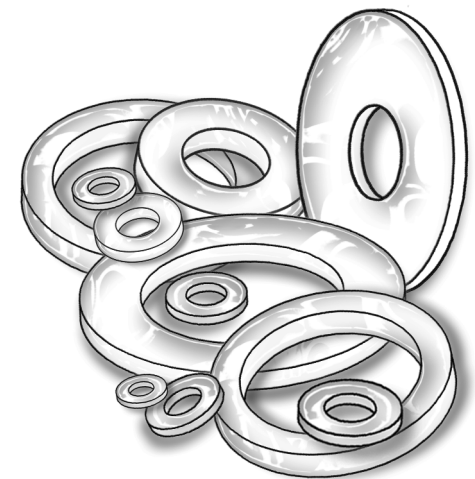
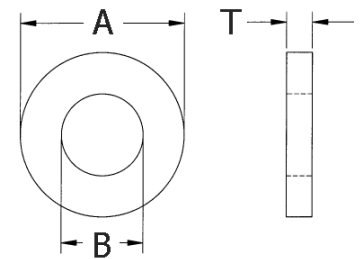

# WASHERS, SHOULDER WASHERS & SCREW INSULATORS

## SECTION IV

### NYLON SPECIAL FLAT WASHERS

**New Sizes**

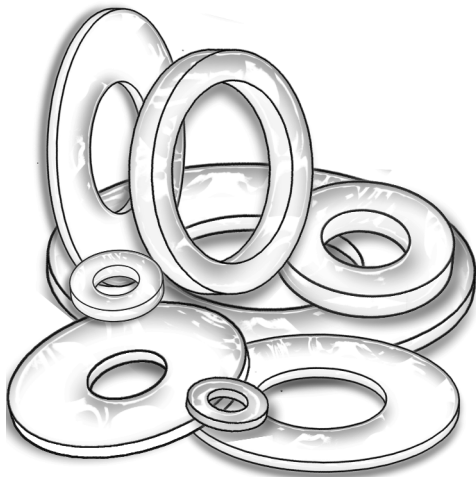
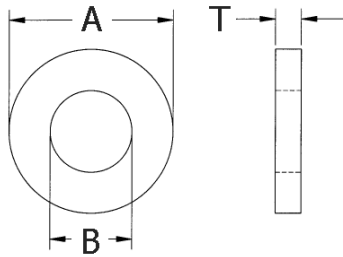

ITEM NUMBER	DESCRIPTION	A	B	T
17W09903	W 9903	1.006 (25,55)	.189 (4,80)	.040 (1,02)
17W09904	W 9904	1.030 (26,16)	.550 (13,97)	.062 (1,57)
17W09930	W 9930	.993 (25,22)	.771 (19,58)	.124 (3,15)
17W09931	W 9931	1.000 (25,40)	.390 (9,91)	.250 (6,35)
17W09932	W 9932	1.000 (25,40)	.390 (9,91)	.175 (4,45)
17W09933	W 9933	1.000 (25,40)	.531 (13,49)	.062 (1,57)
17W09934	W 9934	1.000 (25,40)	.297 (7,54)	.063 (1,60)
17W10000	W 10000	1.000 (25,40)	.156 (3,96)	.062 (1,57)
17W10001	W 10001	1.000 (25,40)	.450 (11,43)	.125 (3,18)
17W10002	W 10002	1.000 (25,40)	.406 (10,31)	.062 (1,57)
17W10003	W 10003	1.00 (25,40)	.562 (14,27)	.125 (3,18)
17W10005	W 10005	1.000 (25,40)	.632 (16,05)	.185 (4,70)
17W10006	W 10006	1.000 (25,40)	.518 (13,16)	.080 (2,03)
17W10007	W 10007	1.000 (25,40)	.730 (18,54)	.062 (1,57)
17W10008	W 10008	1.000 (25,40)	.631 (16,03)	.128 (3,25)
17W10009	W 10009	1.000 (25,40)	.320 (8,13)	.375 (9,53)
17W10010	W 10010	1.000 (25,40)	.505 (12,83)	.125 (3,18)
17W10011	W 10011	1.004 (25,40)	.631 (16,03)	.065 (1,65)
17W10012	W 10012	1.000 (25,40)	.254 (6,45)	.325 (8,26)
17W10013	W 10013	1 (25,40)	.312 (7,92)	.032 (0,81)
17W10014	W 10014	1 (25,40)	5/16 (7,94)	3/16 (4,76)
17W10015	W 10015	1 (25,40)	17/64 (6,74)	5/16 (7,94)
17W10016	W 10016	1.000 (25,40)	.500 (12,70)	.100 (2,54)
17W10017	W 10017	1.000 (25,40)	.755 (19,18)	.175 (4,45)
17W10018	W 10018	1.500 (38,10)	1.015 (25,78)	.250 (6,35)
17W10019	W 10019	1" (25,40)	.665 (16,89)	.125 (3,18)
17W10020	W 10020	1.000 (25,40)	.326 (8,28)	.125 (3,18)
17W10021	W 10021	1.000 (25,40)	.194 (4,93)	.160 (4,06)
17W10022	W 10022	1.024 (26,01)	.563 (14,30)	.220 (5,59)
17W10023	W 10023	1" (25,40)	1/2" (12,70)	1/16" (1,59)
17W10024	W 10024	1.000 (25,40)	.093 (2,36)	.125 (3,18)
17W10025	W 10025	.995 (25,27)	.635 (16,13)	.250 (6,35)
17W10027	W 10027	1.000 (25,40)	.500 (12,70)	.187 (4,75)
17W10028	W 10028	1.000 (25,40)	.509 (12,93)	.125 (3,18)
17W10029	W 10029	1.000 (25,40)	.640 (16,26)	.128 (3,25)
17W10030	W 10030	1.000 (25,40)	.440 (11,18)	.060 (1,52)
17W10041	W 10041	1.000 (25,40)	.264 (6,71)	.070 (1,78)
17W10042	W 10042	.750 (19,05)	.515 (13,08)	.250 (6,35)
17W10043	W 10043	1.000 (25,40)	.265 (6,73)	.262 (6,65)
17W10060	W 10060	1.006 (25,52)	.189 (4,80)	.064 (1,63)
17W10100	W 10100	1.010 (25,65)	.410 (10,41)	.100 (2,54)
17W10311	W 10311	1.031 (26,19)	.844 (21,44)	.040 (1,02)
17W10570	W 10570	1.057 (26,85)	.812 (20,62)	.125 (3,18)
17W10571	W 10571	1 (25,40)	.844 (21,44)	.125 (3,18)
17W10620	W 10620	1.060 (26,92)	.740 (18,80)	.10 (2,54)
17W10622	W 10622	1.062 (26,97)	.740 (18,80)	.225 (5,72)
17W10625	W 10625	1.055 (26,80)	.406 (10,31)	1/4 (6,35)
17W10626	W 10626	1.102 (28,00)	.728 (18,49)	.039 (0,99)
17W10627	W 10627	1.135 (28,83)	1.022 (25,96)	.500 (12,70)
17W11000	W 11000	1.128 (28,65)	.605 (15,37)	.239 (6,07)
17W11001	W 11001	1.181 (30,00)	.413 (10,49)	.098 (2,49)
17W11002	W 11002	1.117 (28,37)	.875 (22,23)	.195 (4,95)
17W11140	W 11140	1.114 (28,30)	.840 (21,34)	.127 (3,23)



# WASHERS, SHOULDER WASHERS & SCREW INSULATORS

## NYLON SPECIAL FLAT WASHERS

SECTION  
IV

ITEM NUMBER	DESCRIPTION	A	B	T
17W11202	W 11202	1.120 (28,45)	.390 (9,91)	.125 (3,18)
17W11203	W 11203	1.120 (28,45)	.503 (12,78)	.033 (0,84)
17W11204	W 11204	1.120 (28,45)	.635 (16,13)	.140 (3,56)
17W11210	W 11210	1-1/8 (28,58)	.320 (8,13)	.062 (1,57)
17W11211	W 11211	1.121 (28,47)	.316 (8,03)	.034 (0,86)
17W11212	W 11212	1.13 (28,70)	.63 (16,00)	1/16 (1,59)
17W11251	W 11251	1.120 (28,45)	.540 (13,72)	.125 (3,18)
17W11256	W 11256	1.125 (28,58)	.889 (22,58)	.060 (1,52)
17W11257	W 11257	1.125 (28,58)	.500 (12,70)	.062 (1,57)
17W11258	W 11258	1.125 (28,58)	.763 (19,38)	.125 (3,18)
17W11259	W 11259	1.125 (28,58)	.920 (23,37)	.126 (3,20)
17W11320	W 11320	1.132 (28,75)	.942 (23,93)	.130 (3,30)
17W11720	W 11720	1.17 (29,72)	.377 (9,58)	.125 (3,18)
17W11750	W 11750	1.175 (29,85)	.310 (7,87)	.125 (3,18)
17W11800	W 11800	1.184 (30,07)	.477 (12,12)	.079 (2,01)
17W12030	W 12030	1.220 (30,99)	.502 (12,75)	.150 (3,81)
17W12031	W 12031	1.203 (30,56)	.984 (24,99)	.050 (1,27)
17W12032	W 12032	1.28 (32,57)	.88 (22,35)	.062 (1,57)
17W12181	W 12181	1.218 (30,94)	1.031 (26,19)	.040 (1,02)
17W12250	W 12250	1.225 (31,12)	.643 (16,33)	.100 (2,54)
17W12251	W 12251	1.245 (31,62)	1.001 (25,43)	.031 (0,79)
17W12501	W 12501	1.235 (31,37)	.365 (9,27)	.110 (2,79)
17W12502	W 12502	1.250 (31,75)	.875 (22,23)	.125 (3,18)
17W12503	W 12503	1.250 (31,75)	.765 (19,43)	.080 (2,03)
17W12504	W 12504	1.250 (31,75)	.516 (13,11)	.062 (1,57)
17W12505	W 12505	1.267 (32,18)	.390 (9,91)	.045 (1,14)
17W12506	W 12506	1.250 (31,75)	.250 (6,35)	.255 (6,48)
17W12507	W 12507	1.250 (31,75)	.805 (20,45)	.060 (1,52)
17W12508	W 12508	1.250 (31,75)	.281 (7,14)	.063 (1,60)
17W12509	W 12509	1 1/4 (31,75)	9/16 (14,29)	1/32 (0,79)
17W12510	W 12510	1.250 (31,75)	.812 (20,62)	.080 (2,03)
17W12511	W 12511	1 17/64 (32,13)	.390 (9,90)	.156 (3,96)
17W12512	W 12512	1.250 (31,75)	.380 (9,66)	.125 (3,18)
17W12513	W 12513	1.250 (31,75)	.310 (7,87)	.120 (3,05)
17W12515	W 12515	1.250 (31,75)	.226 (5,74)	.125 (3,18)
17W12516	W 12516	1 1/4" (31,75)	.260 (6,60)	.060 (1,52)
17W12517	W 12517	1.250 (31,75)	.839 (21,31)	.040 (1,02)
17W12518	W 12518	1.250 (31,75)	.437 (11,10)	.125 (3,18)
17W12525	W 12525	1.260 (32,00)	.340 (8,64)	.250 (6,35)
17W12527	W 12527	1.250 (31,75)	.257 (6,53)	.255 (6,48)
17W12528	W 12528	1.250 (31,75)	.270 (6,86)	.080 (2,03)
17W12562	W 12562	1 1/4 (31,75)	.250 (6,35)	.062 (1,57)
17W12580	W 12580	1.258 (31,95)	.226 (5,74)	.065 (1,65)
17W12593	W 12593	1.250 (31,75)	.100 (2,54)	.060 (1,52)
17W12604	W 12604	1.27 (32,36)	.400 (10,16)	.062 (1,57)
17W13101	W 13101	1.310 (33,27)	.645 (16,38)	.120 (3,05)
17W13119	W 13119	1.312 (33,32)	.510 (12,95)	.400 (10,16)
17W13120	W 13120	1.312 (33,32)	1.000 (25,40)	.191 (4,85)
17W13121	W 13121	1.312 (33,32)	1.088 (27,36)	.062 (1,57)
17W13122	W 13122	1.312 (33,32)	1.000 (25,40)	.125 (3,18)
17W13123	W 13123	1.375 (34,93)	.640 (16,26)	.090 (2,29)
17W13125	W 13125	1.312 (33,32)	1.026 (26,06)	.191 (4,85)
17W13126	W 13126	1.312 (33,32)	.625 (15,88)	.050 (1,27)

New Sizes

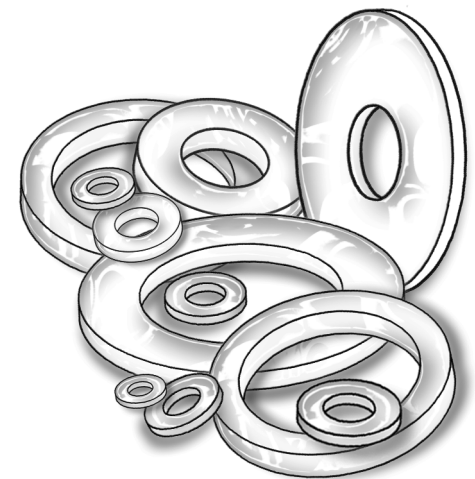
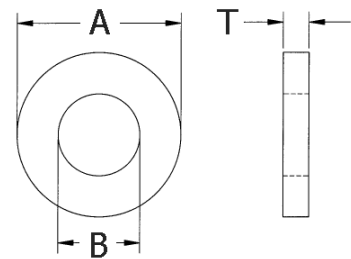



# WASHERS, SHOULDER WASHERS & SCREW INSULATORS

## SECTION IV

### NYLON SPECIAL FLAT WASHERS

**New Sizes**

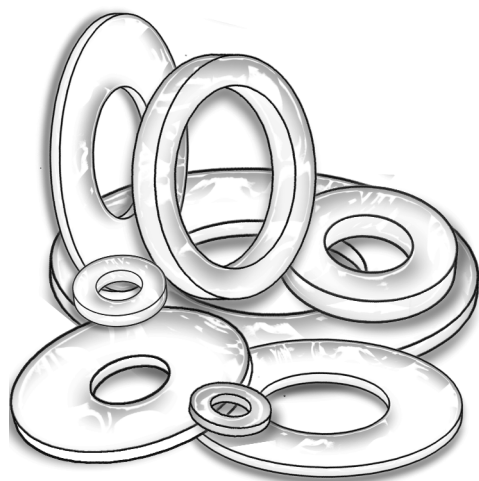
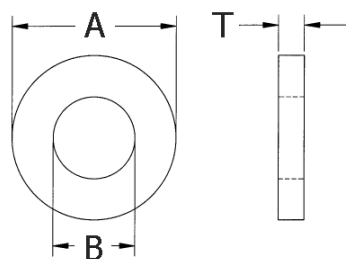

ITEM NUMBER	DESCRIPTION	A	B	T
17W13748	W 13748	1.375 (34,93)	.250 (6,35)	.750 (19,05)
17W13749	W 13749	1.370 (24,80)	.380 (7,65)	.125 (3,18)
17W13750	W 13750	1.375 (34,93)	.250 (6,35)	.064 (7,63)
17W13751	W 13751	1.375 (34,93)	.525 (13,34)	.125 (3,18)
17W13752	W 13752	1.375 (34,93)	.510 (12,95)	.062 (1,57)
17W13753	W 13753	1.375 (34,93)	.656 (16,66)	.125 (3,18)
17W13754	W 13754	1.375 (34,93)	.330 (8,32)	.125 (3,18)
17W13755	W 13755	1.31 (33,27)	.938 (23,82)	.040 (1,02)
17W13756	W 13756	1.363 (34,62)	.523 (13,28)	.051 (1,30)
17W13757	W 13757	1.375 (34,93)	.450 (11,43)	.090 (2,29)
17W13758	W 13758	1.375 (34,93)	.530 (13,46)	.173 (4,39)
17W13759	W 13759	1.375 (34,93)	1.015 (25,78)	.125 (3,18)
17W13760	W 13760	1 3/8 (34,93)	.470 (11,94)	.093 (2,36)
17W14250	W 14250	1.420 (36,07)	.760 (19,30)	.100 (1,54)
17W14251	W 14251	1.395 (35,43)	.250 (6,35)	.118 (3,00)
17W14371	W 14371	1.437 (36,50)	1.000 (25,40)	.069 (1,75)
17W14501	W 14501	1.450 (36,83)	1.000 (25,40)	.063 (1,65)
17W14502	W 14502	1.450 (36,83)	.990 (25,15)	.120 (3,05)
17W14610	W 14610	1.460 (37,08)	1.180 (29,97)	.100 (2,54)
17W14681	W 14681	1.468 (37,29)	.515 (13,08)	.050 (1,27)
17W14930	W 14930	1.500 (38,10)	.437 (11,10)	.130 (3,30)
17W14931	W 14931	1 1/2 (38,10)	.505 (12,83)	.125 (3,18)
17W14932	W 14932	1.500 (38,10)	.265 (6,73)	.375 (9,53)
17W14933	W 14933	1 1/2 (38,10)	5/16 (7,94)	1/16 (1,59)
17W15000	W 15000	1.500 (38,10)	.188 (4,75)	.068 (1,72)
17W15001	W 15001	1.500 (38,10)	.665 (16,89)	.094 (2,39)
17W15002	W 15002	1.500 (38,10)	.500 (12,70)	.125 (3,18)
17W15003	W 15003	1.500 (38,10)	.375 (9,53)	.375 (9,53)
17W15004	W 15004	1.500 (38,10)	.755 (19,18)	.125 (3,18)
17W15005	W 15005	1.500 (38,10)	.696 (17,68)	.120 (3,05)
17W15006	W 15006	1.490 (37,85)	.521 (13,23)	.120 (3,05)
17W15007	W 15007	1.575 (40,01)	.659 (16,74)	.118 (3,00)
17W15008	W 15008	1.500 (38,10)	1.015 (25,78)	.080 (2,03)
17W15009	W 15009	1 1/2 (38,10)	1 1/4 (31,75)	1/8 (3,18)
17W15010	W 15010	1.493 (37,92)	.604 (15,34)	.220 (5,59)
17W15011	W 15011	1 1/2 (38,10)	.335 (8,51)	.125 (3,18)
17W15012	W 15012	1.500 (38,10)	.505 (12,83)	.130 (3,30)
17W15013	W 15013	1.500 (38,10)	.507 (12,88)	.250 (6,35)
17W15014	W 15014	1.468 (37,29)	1.010 (25,65)	.112 (2,84)
17W15016	W 15016	1 1/2 (38,10)	.505 (12,83)	.210 (5,33)
17W15017	W 15017	1 1/2 (38,10)	.203 (5,16)	.068 (1,73)
17W15018	W 15018	1.575 (40,01)	.236 (5,99)	.119 (3,02)
17W15031	W 15031	1.500 (38,10)	.515 (13,08)	.7/16 (11,11)
17W15050	W 15050	1.505 (38,23)	.750 (19,05)	.053 (1,35)
17W15051	W 15051	1.49 (37,85)	.81 (20,57)	.062 (1,57)
17W15052	W 15052	1.57 (39,87)	.512 (13,00)	.118 (3,00)
17W15053	W 15053	1.575 (40,01)	.795 (20,19)	.039 (0,99)
17W15400	W 15400	1.540 (39,12)	1.164 (29,57)	.192 (4,88)
17W15620	W 15620	1.563 (39,70)	1" (25,40)	.062 (1,57)
17W15625	W 15625	1-9/16 (39,70)	.630 (16,00)	.062 (1,57)
17W16240	W 16240	1.619 (41,12)	1.495 (37,97)	.245 (6,22)
17W16250	W 16250	1.625 (41,28)	.531 (13,49)	.312 (7,92)
17W16251	W 16251	1.625 (41,28)	1.375 (34,93)	.110 (2,79)



# WASHERS, SHOULDER WASHERS & SCREW INSULATORS

SECTION  
IV

## NYLON SPECIAL FLAT WASHERS

ITEM NUMBER	DESCRIPTION	A	B	T
17W16252	W 16252	1.625 (41,28)	1.0 (25,40)	.187 (4,75)
17W16253	W 16253	1.625 (41,28)	.940 (23,88)	.060 (1,52)
17W16300	W 16300	1.635 (41,53)	1.405 (35,69)	.093 (2,36)
17W16514	W 16514	1.650 (41,91)	1.395 (35,43)	.140 (3,56)
17W16900	W 16900	1.695 (43,05)	1.255 (31,88)	.065 (1,65)
17W17181	W 17181	1.718 (43,64)	.625 (15,88)	.050 (1,27)
17W17241	W 17241	1.724 (43,79)	1.500 (38,10)	.032 (0,81)
17W17242	W 17242	1.750 (44,45)	.812 (20,62)	.125 (3,18)
17W17251	W 17251	1.425 (36,90)	.697 (17,70)	.100 (2,54)
17W17252	W 17252	1.490 (37,85)	.765 (19,43)	.100 (2,54)
17W17500	W 17500	1.750 (44,45)	.928 (23,57)	.275 (6,99)
17W18001	W 18001	1.800 (45,72)	.948 (24,08)	.057 (1,45)
17W18500	W 18500	1.850 (46,99)	1.028 (26,11)	.120 (3,05)
17W19060	W 19060	1.906 (48,41)	1.500 (38,10)	.093 (2,36)
17W20001	W 20001	2.01 (51,05)	1.28 (32,51)	.135 (3,43)
17W20002	W 20002	2.000 (50,80)	.510 (12,95)	.060 (1,52)
17W20003	W 20003	2.000 (50,80)	1.525 (38,75)	.060 (1,52)
17W20004	W 20004	2.000 (50,80)	1.080 (27,43)	.160 (4,06)
17W20006	W 20006	2.000 (50,80)	.630 (16,00)	.125 (3,18)
17W20007	W 20007	2.000 (50,80)	.390 (9,91)	.062 (1,57)
17W20008	W 20008	2 (50,80)	.635 (16,13)	.060 (1,52)
17W20012	W 20012	1.985 (50,42)	1.525 (38,75)	.125 (3,18)
17W20013	W 20013	2.000 (50,80)	1.325 (33,66)	.310 (7,87)
17W20014	W 20014	2.250 (57,15)	1.410 (35,81)	.130 (3,30)
17W20015	W 20015	2.150 (54,61)	.275 (6,99)	.125 (3,18)
17W20062	W 20062	2 (50,80)	.805 (20,45)	.062 (1,57)
17W20600	W 20600	2.060 (52,32)	1.800 (45,72)	.055 (1,40)
17W21350	W 21350	2 9/64 (54,38)	1.760 (44,70)	.130 (3,30)
17W21850	W 21850	2.180 (55,37)	1.420 (36,07)	.050 (1,27)
17W22005	W 22005	2.205 (56,01)	1.720 (43,69)	.050 (1,27)
17W22500	W 22500	2 1/4 (57,15)	1 (25,40)	.075 (1,91)
17W22800	W 22800	2.275 (57,79)	1.275 (32,39)	.120 (3,05)
17W25001	W 25001	2.500 (63,50)	1.075 (27,31)	.125 (3,18)
17W25003	W 25003	2.500 (63,50)	1.750 (44,45)	.125 (3,18)
17W26802	W 26802	2.69 (68,33)	1.93 (49,02)	.125 (3,18)
17W29300	W 29300	2.930 (74,42)	.632 (16,05)	.150 (3,81)
17W29503	W 29503	2.935 (74,93)	1.125 (28,60)	.093 (2,54)
17W30000	W 30000	3.000 (76,20)	1.270 (32,26)	.093 (2,36)
17W30002	W 30002	2.970 (75,44)	1.490 (37,85)	.125 (3,18)
17W30003	W 30003	3.016 (76,61)	2.800 (71,12)	.122 (3,10)
17W30300	W 30300	3.600 (91,44)	3.030 (76,96)	.075 (1,91)
17W30062	W 30062	2-31/32 (75,41)	.805 (20,45)	1/16 (1,59)
17W30073	W 30073	3.016 (76,61)	2.80 (71,12)	.072 (1,83)
17W30093	W 30093	2.995 (76,07)	1.625 (41,28)	.093 (2,36)
17W31250	W 31250	3.132 (79,55)	.812 (20,62)	.125 (3,18)
17W32600	W 32600	3.260 (82,80)	2.620 (66,55)	.062 (1,57)
17W37500	W 37500	3.750 (95,25)	.375 (9,53)	.062 (1,57)

New Sizes

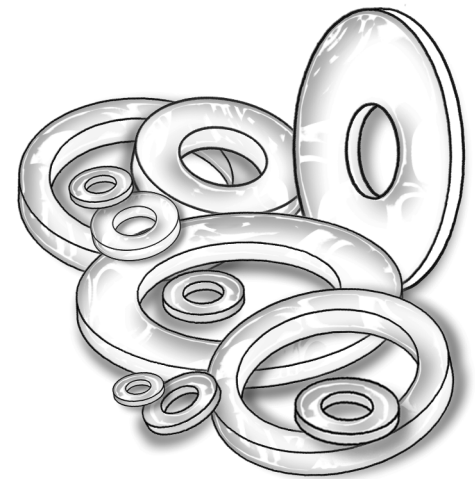
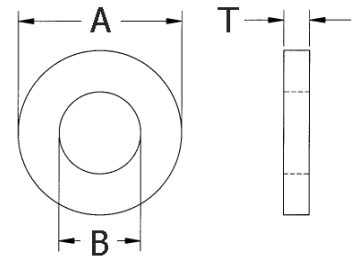

# WASHERS, SHOULDER WASHERS & SCREW INSULATORS

## SECTION IV

### NYLON SHOULDER WASHERS

Nylon Shoulder Washers are suitable for a large variety of insulation and mechanical applications.

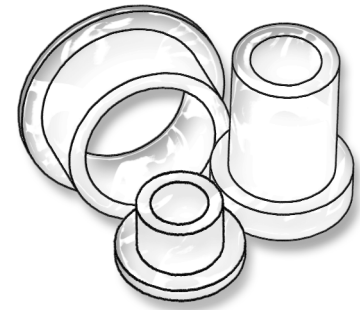

- ▶ THEY SEAL
- ▶ REDUCE VIBRATION
- ▶ ACT AS SPACERS AND GUIDES
- ▶ STRONG AND CORROSION RESISTANT

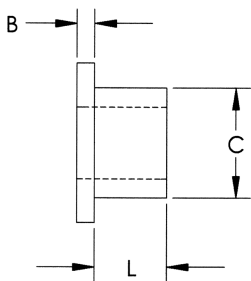
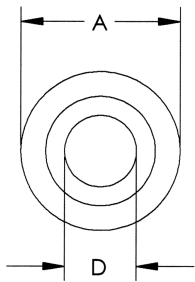

ITEM NUMBER	DESCRIPTION	L	A	B	C	D
12SWS0152	SWS 152	3/64 (1,19)	.105 (2,67)	3/64 (1,19)	.084 (2,13)	.061 (1,55)
12SWS0155	SWS 155	.060 (1,52)	.125 (3,18)	.030 (0,76)	.080 (2,03)	.055 (1,40)
12SWS0156	SWS 156	1/32 (0,79)	.228 (5,79)	1/32 (0,79)	.122 (3,10)	.093 (2,36)
12SWS0157	SWS 157	.035 (0,89)	.235 (5,97)	.095 (2,41)	.147 (3,73)	.115 (2,92)
12SWS0158	SWS 158	.250 (6,35)	.187 (4,75)	.047 (1,19)	.120 (3,05)	.090 (2,29)
12SWS0159	SWS 159	.206 (5,28)	.187 (4,75)	.156 (3,96)	.156 (3,96)	.096 (2,44)
12SWS0180	SWS 180	.075 (1,91)	.181 (4,60)	3/64 (1,19)	.120 (3,05)	.045 (1,14)
12SWS0183	SWS 183	1/32 (0,79)	.182 (4,62)	5/64 (1,98)	.125 (3,18)	.085 (2,16)
12SWS0184	SWS 184	1/32 (0,79)	.189 (4,80)	1/16 (1,59)	.119 (3,02)	.095 (2,41)
12SWS0185	SWS 185	.106 (2,69)	.433 (10,10)	.161 (4,09)	.259 (6,58)	.197 (5,00)
12SWS0186	SWS 186	.088 (2,24)	.228 (5,79)	.039 (0,99)	.140 (3,56)	.098 (2,49)
12SWS0187	SWS 187	1/64 (0,41)	.187 (4,75)	1/32 (0,79)	.119 (3,02)	.089 (2,26)
12SWS0188	SWS 188	.030 (0,76)	.187 (4,75)	.030 (0,76)	.131 (3,33)	.090 (2,29)
12SWS0189	SWS 189	.020 (0,51)	.187 (4,75)	.030 (0,76)	.119 (3,02)	.090 (2,29)
12SWS0190	SWS 190	9/32 (7,14)	.197 (5,00)	1/32 (0,79)	.118 (3,00)	.075 (1,91)
12SWS0191	SWS 191	.100 (2,54)	.350 (8,89)	.090 (2,29)	.200 (5,08)	.140 (3,56)
12SWS0192	SWS 192	.052 (1,32)	.253 (6,43)	.047 (1,19)	.136 (3,45)	.120 (3,05)
12SWS0193	SWS 193	.040 (1,02)	.250 (6,35)	.031 (0,79)	.140 (3,56)	.093 (2,36)
12SWS0194	SWS 194	.046 (1,17)	.197 (5,00)	.027 (0,69)	.144 (3,66)	.118 (3,00)
12SWS0195	SWS 195	1/16 (1,59)	.195 (4,95)	1/32 (0,79)	.120 (3,05)	.093 (2,36)
12SWS0196	SWS 196	3/64 (1,19)	.240 (6,09)	1/16 (1,59)	.135 (3,42)	.114 (2,89)
12SWS0197	SWS 197	1/32 (0,79)	.216 (5,48)	3/64 (1,19)	.135 (3,42)	.115 (2,92)
12SWS0198	SWS 198	1/32 (0,79)	.200 (5,08)	1/32 (0,79)	.140 (3,56)	.115 (2,92)
12SWS0199	SWS 199	5/64 (1,98)	.187 (4,75)	1/32 (0,79)	.119 (3,02)	.063 (1,60)
12SWS0200	SWS 200	1/32 (0,79)	.200 (5,08)	5/64 (1,98)	.135 (3,43)	.116 (2,95)
12SWS0201	SWS 201	3/16 (4,76)	.187 (4,75)	1/32 (0,79)	.119 (3,02)	.063 (1,60)
12SWS0202	SWS 202	5/64 (1,98)	.205 (5,21)	1/32 (0,79)	.125 (3,18)	.093 (2,36)
12SWS0203	SWS 203	7/64 (2,77)	.205 (5,21)	1/32 (0,79)	.125 (3,18)	.093 (2,36)
12SWS0204	SWS 204	3/16 (4,76)	.205 (5,21)	1/32 (0,79)	.125 (3,18)	.093 (2,36)
12SWS0205	SWS 205	3/64 (1,19)	.202 (5,13)	1/64 (0,41)	.145 (3,68)	.120 (3,05)
12SWS0206	SWS 206	1/16 (1,59)	.224 (5,69)	1/32 (0,79)	.154 (3,91)	.120 (3,05)
12SWS0207	SWS 207	5/32 (3,97)	.242 (6,15)	3/64 (1,19)	.135 (3,43)	.110 (2,79)
12SWS0208	SWS 208	1/16 (1,59)	.200 (5,08)	1/32 (0,79)	.120 (3,05)	.093 (2,36)
12SWS0209	SWS 209	3/64 (1,19)	.210 (5,33)	1/64 (0,41)	.145 (3,68)	.120 (3,05)
12SWS0210	SWS 210	3/64 (1,19)	.230 (5,84)	1/64 (0,41)	.142 (3,61)	.122 (3,10)
12SWS0211	SWS 211	1/32 (0,79)	.218 (5,54)	3/64 (1,19)	.135 (3,43)	.115 (2,92)
12SWS0212	SWS 212	7/16 (11,11)	.224 (5,69)	1/32 (0,79)	.154 (3,91)	.120 (3,05)
12SWS0213	SWS 213	3/64 (1,19)	.200 (5,08)	1/32 (0,79)	.138 (3,51)	.109 (2,77)
12SWS0214	SWS 214	1/32 (0,79)	.235 (5,97)	3/64 (1,19)	.137 (3,48)	.115 (2,77)
12SWS0215	SWS 215	7/32 (5,55)	.250 (6,35)	11/64 (4,37)	.150 (3,81)	.115 (2,92)
12SWS0216	SWS 216	1/32 (0,79)	.240 (6,10)	1/32 (0,79)	.150 (3,81)	.098 (2,49)
12SWS0217	SWS 217	1/32 (0,79)	.228 (5,79)	3/64 (1,19)	.138 (3,51)	.100 (2,54)
12SWS0218	SWS 218	1/8 (3,18)	.242 (6,15)	3/64 (1,19)	.140 (3,56)	.115 (2,92)
12SWS0219	SWS 219	1/8 (3,18)	.290 (7,37)	1/64 (0,41)	.250 (6,35)	.193 (4,90)
12SWS0220	SWS 220	3/64 (1,19)	.234 (5,94)	3/64 (1,19)	.147 (3,73)	.115 (2,92)



## NYLON SHOULDER WASHERS

Nylon Shoulder Washers are suitable for a large variety of insulation and mechanical applications.

- ▶ THEY SEAL
- ▶ REDUCE VIBRATION
- ▶ ACT AS SPACERS AND GUIDES
- ▶ STRONG AND CORROSION RESISTANT

New Sizes

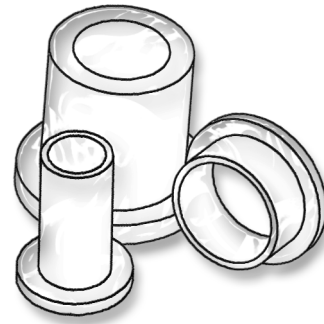

ITEM NUMBER	DESCRIPTION	L		A		B		C		D	
12SWS0221	SWS 221	3/32	(2,38)	.235	(5,97)	3/64	(1,19)	.145	(3,68)	.115	(2,92)
12SWS0222	SWS 222	1/8	(3,18)	.235	(5,97)	3/64	(1,19)	.145	(3,68)	.115	(2,92)
12SWS0223	SWS 223	1/32	(0,79)	.250	(6,35)	1/16	(1,59)	.187	(4,75)	.140	(3,56)
12SWS0224	SWS 224	3/64	(1,19)	.260	(6,60)	1/16	(1,59)	.190	(4,83)	.140	(3,56)
12SWS0225	SWS 225	43/64	(17,02)	.250	(6,35)	3/64	(1,19)	.187	(4,75)	.095	(2,41)
12SWS0226	SWS 226	1/16	(1,59)	.250	(6,35)	1/32	(0,79)	.143	(3,63)	.118	(3,00)
12SWS0227	SWS 227	1/32	(0,79)	.257	(6,53)	1/16	(1,59)	.187	(4,75)	.141	(3,58)
12SWS0228	SWS 228	1/64	(0,41)	.260	(6,60)	1/64	(0,41)	.154	(3,91)	.095	(2,41)
12SWS0229	SWS 229	1/8	(3,18)	.250	(6,35)	3/64	(1,19)	.139	(3,53)	.118	(3,00)
12SWS0230	SWS 230	5/32	(3,97)	.265	(6,73)	1/32	(0,79)	.205	(5,21)	.142	(3,61)
12SWS0232	SWS 232	5/64	(1,98)	.253	(6,42)	3/64	(1,19)	.136	(3,45)	.120	(3,05)
12SWS0233	SWS 233	1/32	(0,79)	.203	(5,16)	3/64	(1,19)	.140	(3,56)	.115	(2,92)
12SWS0234	SWS 234	.050	(1,40)	.239	(6,07)	.020	(0,51)	.139	(3,53)	.116	(2,95)
12SWS0235	SWS 235	.033	(0,84)	.210	(5,33)	.042	(1,07)	.143	(3,63)	.116	(2,95)
12SWS0236	SWS 236	.020	(0,51)	.250	(6,35)	.030	(0,76)	.150	(3,81)	.116	(2,96)
12SWS0237	SWS 237	.040	(1,02)	.235	(5,97)	.047	(1,19)	.147	(3,73)	.115	(2,92)
12SWS0238	SWS 238	.030	(0,76)	.230	(5,84)	.040	(1,02)	.150	(3,81)	.125	(3,18)
12SWS0239	SWS 239	.090	(2,29)	.224	(5,69)	.028	(0,71)	.154	(3,91)	.120	(3,05)
12SWS0240	SWS 240	.100	(2,54)	.230	(5,84)	.025	(0,64)	.190	(4,83)	.150	(3,81)
12SWS0241	SWS 241	.155	(3,94)	.224	(5,69)	.028	(0,71)	.154	(3,91)	.120	(3,05)
12SWS0242	SWS 242	3/32	(2,38)	.635	(16,13)	9/64	(3,57)	.425	(10,80)	.201	(5,11)
12SWS0243	SWS 243	.063	(1,60)	15/64	(5,94)	.025	(0,64)	.164	(4,17)	.130	(3,30)
12SWS0244	SWS 244	.031	(0,79)	.234	(5,94)	.025	(0,64)	.145	(3,68)	.115	(2,92)
12SWS0245	SWS 245	.093	(2,36)	.235	(5,97)	.250	(6,35)	.145	(3,68)	.115	(2,92)
12SWS0246	SWS 246	.027	(0,69)	.240	(6,10)	.047	(1,19)	.134	(3,40)	.115	(2,92)
12SWS0247	SWS 247	3/64	(1,19)	.252	(6,40)	3/64	(1,19)	.140	(3,56)	.115	(2,92)
12SWS0248	SWS 248	.090	(2,29)	.290	(7,37)	.060	(1,52)	.205	(5,21)	.125	(3,18)
12SWS0249	SWS 249	.177	(4,50)	.244	(6,20)	.040	(1,02)	.157	(3,99)	.118	(3,00)
12SWS0250	SWS 250	.156	(3,96)	.265	(6,73)	.118	(3,00)	.205	(5,21)	.142	(3,61)
12SWS0251	SWS 251	.031	(0,79)	.250	(6,35)	.031	(0,79)	.154	(3,91)	.093	(2,36)
12SWS0252	SWS 252	3/64	(1,19)	.240	(6,10)	.130	(3,30)	.138	(3,51)	.114	(2,90)
12SWS0253	SWS 253	.052	(1,32)	.200	(5,08)	.078	(1,98)	.135	(3,43)	.120	(3,05)
12SWS0254	SWS 254	.281	(7,13)	.203	(5,16)	.040	(1,02)	.156	(3,96)	.100	(2,54)
12SWS0255	SWS 255	1/8	(2,94)	.500	(12,70)	1/8	(2,94)	.375	(9,53)	.285	(7,14)
12SWS0256	SWS 256	.100	(2,54)	.243	(6,17)	.060	(1,52)	.199	(5,05)	.125	(3,18)
12SWS0257	SWS 257	.280	(7,11)	.250	(6,35)	.046	(1,17)	.150	(3,81)	.118	(3,00)
12SWS0280	SWS 280	.185	(4,70)	.280	(7,11)	.042	(1,07)	.150	(3,81)	.112	(2,84)
12SWS0290	SWS 290	1/32	(0,79)	.290	(7,37)	3/64	(1,19)	.170	(4,32)	.140	(3,56)
12SWS0291	SWS 291	.375	(9,53)	.290	(7,37)	.234	(5,94)	.170	(4,32)	.140	(3,56)
12SWS0296	SWS 296	.375	(9,53)	.499	(12,67)	.125	(3,18)	.295	(7,49)	.187	(4,75)
12SWS0300	SWS 300	.090	(2,29)	.250	(6,35)	.050	(1,27)	.150	(3,81)	.120	(3,05)
12SWS0301	SWS 301	.065	(1,65)	.250	(6,35)	.030	(0,76)	.140	(3,56)	.098	(2,49)
12SWS0302	SWS 302	.039	(0,99)	.210	(5,33)	.032	(0,81)	.141	(3,58)	.118	(3,00)
12SWS0304	SWS 304	.453	(11,51)	.256	(6,50)	.055	(1,40)	.173	(4,39)	.118	(3,00)
12SWS0305	SWS 305	.120	(3,05)	.250	(6,35)	.050	(1,27)	.135	(3,43)	.118	(3,00)

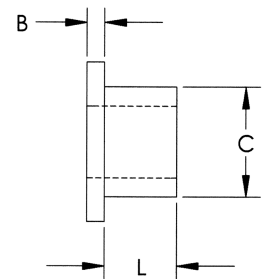
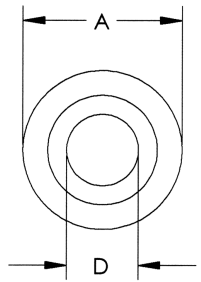

# WASHERS, SHOULDER WASHERS & SCREW INSULATORS

## SECTION IV

### NYLON SHOULDER WASHERS

Nylon Shoulder Washers are suitable for a large variety of insulation and mechanical applications.

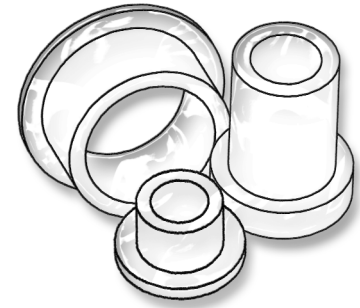

**New Sizes**

- ▶ THEY SEAL
- ▶ REDUCE VIBRATION
- ▶ ACT AS SPACERS AND GUIDES
- ▶ STRONG AND CORROSION RESISTANT

ITEM NUMBER	DESCRIPTION	L	A	B	C	D
12SWS0306	SWS 306	.062 (1,57)	.250 (6,35)	.031 (0,79)	.150 (3,81)	.116 (2,95)
12SWS0310	SWS 310	.250 (6,35)	.250 (6,35)	.047 (1,19)	.156 (3,96)	.125 (3,18)
12SWS0311	SWS 311	.437 (11,10)	.260 (6,60)	.032 (0,81)	.158 (4,01)	.125 (3,18)
12SWS0312	SWS 312	.190 (4,83)	.575 (14,61)	.030 (0,76)	.365 (9,27)	.312 (7,92)
12SWS0364	SWS 364	.453 (11,51)	.364 (9,24)	.055 (1,40)	.244 (6,20)	.197 (5,00)
12SWS0380	SWS 380	.070 (1,78)	.255 (6,48)	.040 (1,02)	.145 (3,68)	.120 (3,05)
12SWS0393	SWS 393	.380 (9,65)	.400 (10,16)	.032 (0,81)	.200 (5,08)	.132 (3,35)
12SWS0394	SWS 394	.226 (5,74)	.276 (7,01)	.030 (0,76)	.236 (5,99)	.177 (4,50)
12SWS0395	SWS 395	.025 (0,64)	.250 (6,35)	.031 (0,79)	.122 (3,10)	.093 (2,36)
12SWS0396	SWS 396	.040 (1,02)	.250 (6,35)	.047 (1,19)	.140 (3,56)	.102 (2,59)
12SWS0397	SWS 397	.032 (0,81)	.250 (6,35)	.063 (1,60)	.150 (3,81)	.116 (2,95)
12SWS0398	SWS 398	.296 (7,52)	.290 (7,37)	.047 (1,19)	.170 (4,32)	.140 (3,56)
12SWS0399	SWS 399	.050 (1,27)	.250 (6,35)	.031 (0,79)	.185 (4,70)	.120 (3,02)
12SWS0400	SWS 400	3/32 (2,38)	.235 (5,97)	3/64 (1,19)	.140 (3,56)	.115 (2,92)
12SWS0401	SWS 401	1/4 (6,35)	.235 (5,97)	3/64 (1,19)	.145 (3,68)	.115 (2,92)
12SWS0402	SWS 402	3/64 (1,19)	.240 (6,09)	1/16 (1,59)	.138 (3,50)	.114 (2,89)
12SWS0403	SWS 403	1/16 (1,59)	.312 (7,93)	1/16 (1,59)	.149 (3,79)	.115 (2,92)
12SWS0404	SWS 404	3/32 (2,38)	.312 (7,93)	1/16 (1,59)	.149 (3,79)	.115 (2,92)
12SWS0405	SWS 405	1/64 (0,41)	.250 (6,35)	3/64 (1,19)	.124 (3,15)	.111 (2,82)
12SWS0406	SWS 406	1/32 (0,79)	.252 (6,40)	1/32 (0,79)	.186 (4,72)	.140 (3,56)
12SWS0407	SWS 407	1/32 (0,79)	.250 (6,35)	1/32 (0,79)	.186 (4,72)	.139 (3,53)
12SWS0408	SWS 408	.250 (6,35)	.235 (5,97)	.032 (0,81)	.120 (3,05)	.090 (2,29)
12SWS0409	SWS 409	1/8 (3,18)	.250 (6,35)	1/32 (0,79)	.195 (4,95)	.130 (3,30)
12SWS0410	SWS 410	1/32 (0,79)	.250 (6,35)	3/64 (1,19)	.114 (2,90)	.100 (2,54)
12SWS0411	SWS 411	1/16 (1,59)	.250 (6,35)	1/32 (0,79)	.143 (3,63)	.115 (2,92)
12SWS0412	SWS 412	1/16 (1,59)	.250 (6,35)	1/32 (0,79)	.169 (4,29)	.102 (2,59)
12SWS0413	SWS 413	3/32 (2,38)	.250 (6,35)	3/64 (1,19)	.114 (2,90)	.100 (2,54)
12SWS0414	SWS 414	1/8 (3,18)	.281 (7,14)	3/32 (2,38)	.158 (4,01)	.093 (2,36)
12SWS0415	SWS 415	3/16 (4,76)	.293 (7,44)	3/64 (1,19)	.218 (5,53)	.138 (3,51)
12SWS0416	SWS 416	11/64 (4,37)	.250 (6,35)	3/64 (1,19)	.186 (4,72)	.126 (3,20)
12SWS0417	SWS 417	1/64 (0,41)	.310 (7,87)	1/16 (1,59)	.183 (4,65)	.139 (3,53)
12SWS0418	SWS 418	1/64 (0,41)	.312 (7,93)	1/16 (1,59)	.187 (4,75)	.115 (2,92)
12SWS0419	SWS 419	1/32 (0,79)	.312 (7,93)	1/32 (0,79)	.185 (4,70)	.140 (3,56)
12SWS0420	SWS 420	1/16 (1,59)	.312 (7,93)	1/16 (1,59)	.170 (4,32)	.120 (3,05)
12SWS0421	SWS 421	3/64 (1,19)	.312 (7,93)	1/16 (1,59)	.170 (4,32)	.127 (3,23)
12SWS0422	SWS 422	1/8 (3,18)	.312 (7,93)	3/64 (1,19)	.234 (5,94)	.144 (3,66)
12SWS0423	SWS 423	1/64 (0,41)	.250 (6,35)	1/32 (0,79)	.150 (3,81)	.116 (2,95)
12SWS0424	SWS 424	7/32 (5,55)	.295 (7,49)	1/32 (0,79)	.234 (5,94)	.140 (3,56)
12SWS0425	SWS 425	1/32 (0,79)	.312 (7,93)	1/16 (1,59)	.250 (6,35)	.196 (4,98)
12SWS0426	SWS 426	11/64 (4,37)	.250 (6,35)	3/64 (1,19)	.145 (3,68)	.115 (2,92)
12SWS0427	SWS 427	3/64 (1,19)	.250 (6,35)	1/32 (0,79)	.185 (4,70)	.116 (2,95)
12SWS0428	SWS 428	7/64 (2,77)	.242 (6,15)	3/64 (1,19)	.140 (3,56)	.115 (2,92)
12SWS0429	SWS 429	9/64 (3,58)	.250 (6,35)	3/64 (1,19)	.145 (3,68)	.115 (2,92)
12SWS0430	SWS 430	3/16 (4,76)	.312 (7,93)	1/16 (1,59)	.250 (6,35)	.156 (3,96)
12SWS0431	SWS 431	3/32 (2,38)	.240 (6,10)	1/32 (0,79)	.185 (4,70)	.125 (3,18)

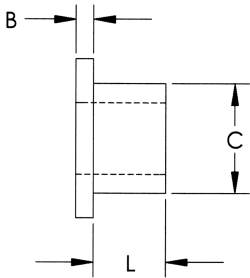
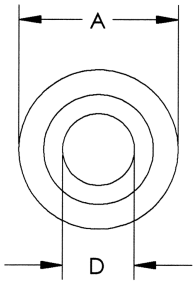

# WASHERS, SHOULDER WASHERS & SCREW INSULATORS

SECTION  
IV

## NYLON SHOULDER WASHERS

Nylon Shoulder Washers are suitable for a large variety of insulation and mechanical applications.

- ▶ THEY SEAL
- ▶ REDUCE VIBRATION
- ▶ ACT AS SPACERS AND GUIDES
- ▶ STRONG AND CORROSION RESISTANT

**New Sizes**

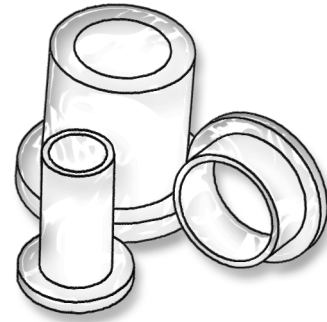

ITEM NUMBER	DESCRIPTION	L	A	B	C	D
12SWS0432	SWS 432	3/64 (1,19)	.250 (6,35)	3/64 (1,19)	.143 (3,63)	.113 (2,87)
12SWS0433	SWS 433	7/64 (2,77)	.250 (6,35)	3/64 (1,19)	.145 (3,68)	.115 (2,92)
12SWS0434	SWS 434	1/16 (1,59)	.312 (7,93)	3/64 (1,19)	.170 (4,32)	.140 (3,56)
12SWS0435	SWS 435	3/64 (1,19)	.250 (6,35)	1/16 (1,59)	.185 (4,70)	.116 (2,95)
12SWS0436	SWS 436	1/32 (0,79)	.240 (6,10)	3/64 (1,19)	.139 (3,53)	.115 (2,92)
12SWS0437	SWS 437	1/32 (0,79)	.265 (6,73)	1/32 (0,79)	.157 (3,99)	.126 (3,20)
12SWS0438	SWS 438	1/32 (0,79)	.312 (7,93)	1/16 (1,59)	.187 (4,75)	.141 (3,58)
12SWS0439	SWS 439	1/16 (1,59)	.250 (6,35)	3/64 (1,19)	.138 (3,50)	.120 (3,05)
12SWS0440	SWS 440	5/16 (7,94)	.312 (7,93)	1/32 (0,79)	.154 (3,91)	.130 (3,30)
12SWS0441	SWS 441	3/16 (4,76)	.312 (7,93)	1/32 (0,79)	.234 (5,94)	.184 (4,67)
12SWS0442	SWS 442	7/32 (5,54)	.296 (7,52)	1/32 (0,79)	.235 (5,97)	.135 (3,43)
12SWS0443	SWS 443	.156 (3,96)	.252 (6,40)	.047 (1,19)	.140 (3,56)	.115 (2,92)
12SWS0444	SWS 444	1/16 (1,59)	.300 (7,62)	3/64 (1,19)	.194 (4,93)	.160 (4,06)
12SWS0445	SWS 445	1/32 (0,79)	.313 (7,95)	1/32 (0,79)	.175 (4,45)	.143 (3,63)
12SWS0446	SWS 446	1/64 (0,41)	.312 (7,93)	3/64 (1,19)	.160 (4,06)	.097 (2,46)
12SWS0448	SWS 448	3/32 (2,38)	.312 (7,93)	3/64 (1,19)	.187 (4,75)	.128 (3,25)
12SWS0449	SWS 449	1/32 (0,79)	.313 (7,95)	1/32 (0,79)	.219 (5,56)	.124 (3,15)
12SWS0450	SWS 450	1/16 (1,59)	.312 (7,93)	3/64 (1,19)	.234 (5,94)	.144 (3,66)
12SWS0451	SWS 451	1/32 (0,79)	.315 (8,00)	.030 (0,76)	.150 (3,81)	.115 (2,92)
12SWS0452	SWS 452	1/32 (0,79)	.312 (7,93)	3/64 (1,19)	.203 (5,16)	.120 (3,05)
12SWS0453	SWS 453	.027 (0,69)	.312 (7,93)	.035 (0,89)	.187 (4,75)	.140 (3,56)
12SWS0454	SWS 454	1/32 (0,79)	.313 (7,95)	1/32 (0,79)	.219 (5,56)	.136 (3,45)
12SWS0455	SWS 455	3/64 (1,19)	.315 (8,00)	1/32 (0,79)	.185 (4,70)	.126 (3,20)
12SWS0456	SWS 456	3/64 (1,19)	.250 (6,35)	3/64 (1,19)	.156 (3,96)	.115 (2,92)
12SWS0457	SWS 457	.031 (0,79)	.250 (6,35)	.031 (0,79)	.187 (4,75)	.120 (3,05)
12SWS0458	SWS 458	.078 (1,98)	.312 (7,92)	.031 (0,79)	.185 (4,70)	.128 (3,25)
12SWS0459	SWS 459	15/64 (5,94)	.291 (7,39)	1/16 (1,59)	.154 (3,91)	.120 (3,05)
12SWS0460	SWS 460	.125 (3,18)	.290 (7,37)	.047 (1,19)	.170 (4,32)	.140 (3,56)
12SWS0462	SWS 462	.031 (0,79)	.312 (7,93)	.063 (1,60)	.187 (4,75)	.123 (3,12)
12SWS0463	SWS 463	.050 (1,27)	.312 (7,93)	.046 (1,17)	.229 (5,82)	.163 (4,13)
12SWS0464	SWS 464	19/64 (7,52)	.250 (6,35)	3/64 (1,19)	.145 (3,68)	.115 (2,92)
12SWS0465	SWS 465	.060 (1,52)	.312 (7,93)	.030 (0,76)	.189 (4,80)	.144 (3,66)
12SWS0466	SWS 466	.025 (0,64)	.307 (7,80)	.035 (0,89)	.154 (3,91)	.093 (2,36)
12SWS0467	SWS 467	.062 (1,57)	.312 (7,93)	.063 (1,60)	.126 (3,20)	.091 (0,23)
12SWS0468	SWS 468	.250 (6,35)	.312 (7,93)	.060 (1,52)	.210 (5,33)	.142 (3,61)
12SWS0469	SWS 469	.122 (3,10)	.388 (9,85)	.187 (4,75)	.207 (5,26)	.160 (4,06)
12SWS0470	SWS 470	.165 (4,19)	.290 (7,37)	.047 (1,19)	.200 (5,08)	.145 (3,68)
12SWS0472	SWS 472	.027 (0,69)	.316 (8,03)	.096 (2,44)	.181 (4,60)	.150 (3,81)
12SWS0473	SWS 473	.600 (15,24)	.290 (7,39)	.047 (1,19)	.210 (5,33)	.140 (3,56)
12SWS0474	SWS 474	.312 (7,92)	.312 (7,92)	.058 (1,47)	.185 (4,70)	.125 (3,18)
12SWS0475	SWS 475	.100 (2,54)	.312 (7,93)	.045 (1,14)	.150 (3,81)	.114 (2,90)
12SWS0476	SWS 476	.052 (1,32)	.300 (7,62)	.035 (0,89)	.087 (2,21)	.055 (1,40)
12SWS0477	SWS 477	.067 (1,70)	.308 (7,82)	.045 (1,14)	.183 (4,65)	.132 (3,35)
12SWS0478	SWS 478	.750 (19,05)	.325 (8,26)	.047 (1,19)	.220 (5,59)	.140 (3,56)
12SWS0479	SWS 479	.187 (4,75)	5/16 (7,94)	.062 (1,58)	.172 (4,37)	.147 (3,73)

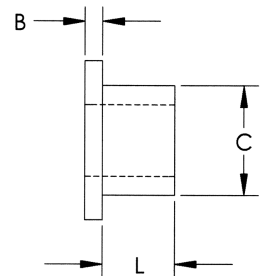
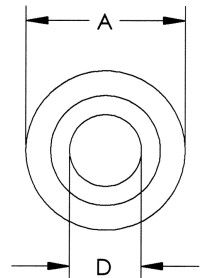

# WASHERS, SHOULDER WASHERS & SCREW INSULATORS

## SECTION IV

### NYLON SHOULDER WASHERS

Nylon Shoulder Washers are suitable for a large variety of insulation and mechanical applications.

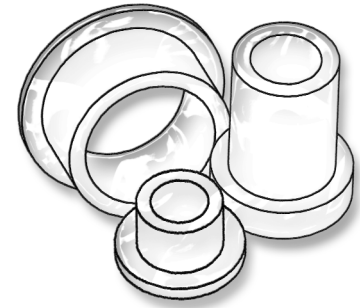

- ▶ THEY SEAL
- ▶ REDUCE VIBRATION
- ▶ ACT AS SPACERS AND GUIDES
- ▶ STRONG AND CORROSION RESISTANT

**New Sizes**

ITEM NUMBER	DESCRIPTION	L	A	B	C	D
12SWS0480	SWS 480	.100 (2,54)	.310 (7,87)	.037 (0,94)	.242 (6,15)	.164 (4,17)
12SWS0601	SWS 601	1/4 (6,35)	.290 (7,37)	3/64 (1,19)	.170 (4,32)	.140 (3,56)
12SWS0602	SWS 602	1/32 (0,79)	.330 (8,38)	1/16 (1,59)	.206 (5,23)	.141 (3,58)
12SWS0603	SWS 603	.062 (1,57)	.300 (7,62)	.050 (1,27)	.180 (4,57)	.150 (3,81)
12SWS0604	SWS 604	.125 (3,18)	.300 (7,62)	.047 (1,19)	.194 (4,93)	.160 (4,06)
12SWS0605	SWS 605	3/64 (1,19)	.328 (8,33)	3/64 (1,19)	.218 (5,54)	.146 (3,71)
12SWS0606	SWS 606	3/64 (1,19)	.340 (8,64)	5/64 (1,98)	.250 (6,35)	.140 (3,56)
12SWS0607	SWS 607	1/16 (1,59)	.289 (7,34)	1/16 (1,59)	.215 (5,46)	.093 (2,36)
12SWS0608	SWS 608	3/64 (1,19)	.290 (7,37)	3/64 (1,19)	.170 (4,32)	.140 (3,56)
12SWS0609	SWS 609	3/64 (1,19)	.312 (7,93)	1/32 (0,79)	.185 (4,70)	.116 (2,95)
12SWS0610	SWS 610	1/16 (1,59)	.348 (8,83)	1/32 (0,79)	.290 (7,36)	.256 (6,50)
12SWS0612	SWS 612	3/32 (2,38)	.316 (8,03)	3/64 (1,19)	.158 (4,01)	.116 (2,95)
12SWS0614	SWS 614	1/32 (0,79)	.324 (8,23)	1/16 (1,59)	.204 (5,18)	.140 (3,56)
12SWS0615	SWS 615	.065 (1,65)	.320 (8,13)	.050 (1,27)	.182 (4,62)	.141 (3,58)
12SWS0616	SWS 616	.126 (3,20)	.320 (8,13)	.039 (0,99)	.250 (6,35)	.218 (5,54)
12SWS0621	SWS 621	3/32 (2,38)	.340 (8,64)	1/16 (1,59)	.220 (5,59)	.175 (4,45)
12SWS0622	SWS 622	.387 (9,83)	.372 (9,45)	.062 (1,57)	.201 (5,11)	.176 (4,47)
12SWS0628	SWS 628	3/8 (9,53)	.345 (8,76)	1/16 (1,59)	.205 (5,21)	.173 (4,39)
12SWS0629	SWS 629	3/64 (1,19)	.345 (8,76)	1/16 (1,59)	.209 (5,30)	.171 (4,34)
12SWS0630	SWS 630	13/64 (5,16)	.368 (9,34)	5/64 (1,98)	.146 (3,70)	.115 (2,92)
12SWS0632	SWS 632	1/16 (1,59)	.349 (8,87)	3/64 (1,19)	.248 (6,30)	.140 (3,56)
12SWS0633	SWS 633	.060 (1,52)	.349 (8,87)	.050 (1,27)	.260 (6,60)	.133 (3,38)
12SWS0634	SWS 634	11/64 (4,37)	.350 (8,89)	1/64 (0,41)	.300 (7,62)	.112 (2,84)
12SWS0635	SWS 635	.070 (1,78)	.375 (9,53)	.04 (1,02)	.190 (4,83)	.125 (3,18)
12SWS0636	SWS 636	.120 (3,05)	.344 (8,74)	.063 (1,60)	.235 (5,97)	.175 (4,45)
12SWS0637	SWS 637	.093 (2,36)	.344 (8,74)	.063 (1,60)	.205 (5,21)	.173 (4,39)
12SWS0798	SWS 798	.085 (2,16)	.344 (8,74)	.063 (1,60)	.235 (5,97)	.175 (4,45)
12SWS0799	SWS 799	3/64 (1,19)	.344 (8,74)	7/64 (2,77)	.189 (4,80)	.141 (3,58)
12SWS0800	SWS 800	9/64 (3,58)	.344 (8,74)	1/16 (1,59)	.210 (5,33)	.170 (4,32)
12SWS0801	SWS 801	3/8 (9,53)	.344 (8,74)	1/16 (1,59)	.205 (5,21)	.173 (4,39)
12SWS0802	SWS 802	1/16 (1,59)	.375 (9,53)	1/32 (0,79)	.195 (4,95)	.171 (4,34)
12SWS0803	SWS 803	13/32 (10,32)	.510 (12,95)	1/16 (1,59)	.250 (6,35)	.171 (4,34)
12SWS0804	SWS 804	.177 (4,50)	.355 (9,02)	.020 (0,51)	.315 (8,00)	.236 (5,99)
12SWS0805	SWS 805	.283 (7,19)	.370 (9,40)	.067 (1,70)	.242 (6,15)	.195 (4,95)
12SWS0806	SWS 806	.250 (6,35)	.344 (8,74)	.032 (0,81)	.205 (5,21)	.173 (4,39)
12SWS0807	SWS 807	.046 (1,17)	.359 (9,12)	.060 (1,52)	.300 (7,62)	.227 (5,77)
12SWS0808	SWS 808	1/8 (3,18)	.375 (9,53)	1/16 (1,59)	.280 (7,11)	.201 (5,10)
12SWS0809	SWS 809	5/32 (3,97)	.378 (9,60)	5/64 (1,98)	.194 (4,92)	.116 (2,94)
12SWS0810	SWS 810	1/32 (0,79)	.375 (9,53)	1/16 (1,59)	.250 (6,35)	.171 (4,34)
12SWS0811	SWS 811	3/64 (1,19)	.375 (9,53)	3/64 (1,19)	.245 (6,22)	.192 (4,88)
12SWS0812	SWS 812	3/32 (2,38)	.375 (9,53)	1/32 (0,79)	.260 (6,60)	.220 (5,59)
12SWS0813	SWS 813	7/64 (2,77)	.375 (9,53)	3/64 (1,19)	.195 (4,95)	.136 (3,45)
12SWS0814	SWS 814	3/64 (1,19)	.375 (9,53)	5/64 (1,98)	.244 (6,20)	.150 (3,81)
12SWS0815	SWS 815	3/32 (2,38)	.375 (9,53)	1/32 (0,79)	.185 (4,70)	.140 (3,56)
12SWS0816	SWS 816	1/32 (0,79)	.375 (9,53)	1/32 (0,79)	.250 (6,35)	.169 (4,29)

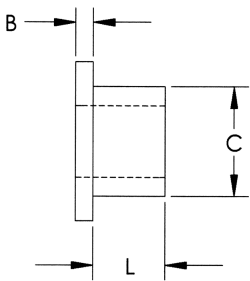
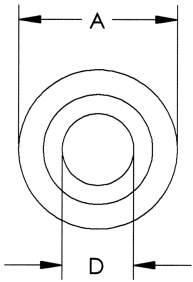

# WASHERS, SHOULDER WASHERS & SCREW INSULATORS

SECTION  
IV

## NYLON SHOULDER WASHERS

Nylon Shoulder Washers are suitable for a large variety of insulation and mechanical applications.

- ▶ THEY SEAL
- ▶ REDUCE VIBRATION
- ▶ ACT AS SPACERS AND GUIDES
- ▶ STRONG AND CORROSION RESISTANT

**New Sizes**

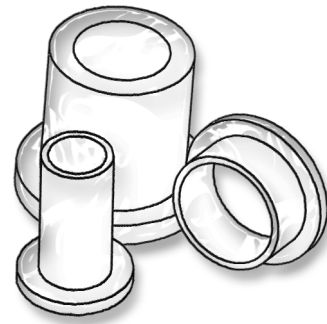

ITEM NUMBER	DESCRIPTION	L	A	B	C	D
12SWS0817	SWS 817	3/64 (1,19)	.375 (9,53)	1/16 (1,59)	.218 (5,54)	.140 (3,56)
12SWS0818	SWS 818	1/32 (0,79)	.375 (9,53)	1/16 (1,59)	.246 (6,25)	.167 (4,24)
12SWS0819	SWS 819	1/16 (1,59)	.437 (11,10)	1/16 (1,59)	.313 (7,95)	.188 (4,78)
12SWS0820	SWS 820	1/32 (0,79)	.375 (9,53)	1/16 (1,59)	.185 (4,70)	.140 (3,56)
12SWS0821	SWS 821	1/32 (0,79)	.381 (9,68)	1/16 (1,59)	.308 (7,82)	.196 (4,98)
12SWS0822	SWS 822	1/32 (0,79)	.374 (9,50)	1/32 (0,79)	.246 (6,24)	.141 (3,58)
12SWS0823	SWS 823	.099 (2,51)	.375 (9,53)	.040 (1,02)	.250 (6,35)	.171 (4,34)
12SWS0824	SWS 824	.05 (1,27)	3/8 (9,53)	.06 (1,52)	.245 (6,22)	.140 (3,56)
12SWS0825	SWS 825	.060 (1,52)	.375 (9,53)	.030 (0,76)	.245 (6,22)	.145 (3,68)
12SWS0826	SWS 826	.062 (1,57)	.500 (12,70)	1/16 (1,59)	.308 (7,82)	.196 (4,98)
12SWS0827	SWS 827	.046 (1,17)	.375 (9,53)	.040 (1,02)	.250 (6,35)	.171 (4,34)
12SWS0828	SWS 828	.125 (3,18)	.380 (9,65)	.065 (1,65)	.254 (6,45)	.196 (4,98)
12SWS0829	SWS 829	1/8 (3,18)	.370 (9,40)	.110 (2,79)	.307 (7,80)	.255 (6,48)
12SWS0830	SWS 830	.032 (0,81)	.375 (9,53)	.062 (1,57)	.187 (4,75)	.147 (3,73)
12SWS0831	SWS 831	.250 (6,35)	.375 (9,53)	.040 (1,02)	.250 (6,35)	.171 (4,34)
12SWS0832	SWS 832	.043 (1,09)	.375 (9,53)	.035 (0,76)	.257 (6,53)	.193 (4,90)
12SWS0833	SWS 833	.050 (1,27)	.375 (9,53)	.031 (0,79)	.243 (6,17)	.199 (5,05)
12SWS0834	SWS 834	.015 (0,38)	.375 (9,53)	.057 (1,45)	.304 (7,72)	.200 (5,08)
12SWS0835	SWS 835	.050 (1,27)	.377 (9,58)	.050 (1,27)	.245 (6,22)	.155 (3,94)
12SWS0836	SWS 836	.030 (0,76)	.375 (9,53)	.063 (1,60)	.250 (6,35)	.174 (4,42)
12SWS0837	SWS 837	.031 (0,79)	.375 (9,53)	.062 (1,57)	.187 (4,75)	.093 (2,36)
12SWS0838	SWS 838	.180 (4,57)	.350 (8,89)	.067 (1,70)	.240 (6,10)	.188 (4,78)
12SWS0839	SWS 839	.050 (1,27)	.385 (9,78)	.030 (0,76)	.250 (6,35)	.169 (4,29)
12SWS0840	SWS 840	13/64 (5,16)	.370 (9,40)	5/64 (1,98)	.145 (3,68)	.115 (2,92)
12SWS0841	SWS 841	1/8" (3,17)	3/8" (9,52)	.035 (0,89)	.242 (6,15)	.185 (4,70)
12SWS0842	SWS 842	5/64 (1,98)	.375 (9,53)	7/32 (5,55)	.199 (5,05)	.140 (3,56)
12SWS0843	SWS 843	.072 (1,83)	.385 (9,78)	.051 (1,30)	.250 (6,35)	.137 (3,48)
12SWS0844	SWS 844	3/64 (1,19)	.381 (9,68)	1/16 (1,59)	.185 (4,70)	.140 (3,56)
12SWS0845	SWS 845	.346 (8,79)	.370 (9,40)	.031 (0,79)	.242 (6,15)	.180 (4,57)
12SWS0846	SWS 846	1/16 (1,59)	.375 (9,53)	3/32 (2,38)	.250 (6,35)	.140 (3,56)
12SWS0847	SWS 847	.213 (5,14)	.375 (9,53)	1/16 (1,59)	.250 (6,35)	.197 (5,00)
12SWS0848	SWS 848	1/32 (0,79)	.385 (9,78)	1/16 (1,59)	.240 (6,10)	.145 (3,68)
12SWS0849	SWS 849	.060 (1,52)	.375 (9,53)	.030 (0,76)	.312 (7,92)	.253 (6,43)
12SWS0850	SWS 850	1/16 (1,59)	.375 (9,53)	3/32 (2,38)	.250 (6,35)	.138 (3,51)
12SWS0852	SWS 852	3/32 (2,38)	.375 (9,53)	1/16 (1,59)	.248 (6,30)	.136 (3,45)
12SWS0853	SWS 853	.030 (0,76)	.380 (9,65)	.066 (1,68)	.250 (6,35)	.190 (4,83)
12SWS0854	SWS 854	3/64 (1,19)	.375 (9,53)	1/16 (1,59)	.240 (6,10)	.194 (4,93)
12SWS0855	SWS 855	7/64 (2,77)	.375 (9,53)	1/16 (1,59)	.240 (6,10)	.138 (3,51)
12SWS0856	SWS 856	3/32 (2,38)	.375 (9,53)	1/64 (0,41)	.185 (4,70)	.140 (3,56)
12SWS0857	SWS 857	5/32 (3,97)	.375 (9,53)	5/64 (1,98)	.193 (4,90)	.116 (2,95)
12SWS0858	SWS 858	1/16 (1,59)	.375 (9,53)	1/16 (1,59)	.250 (6,35)	.145 (3,68)
12SWS0859	SWS 859	9/64 (3,58)	.375 (9,53)	1/32 (0,79)	.245 (6,22)	.187 (4,75)
12SWS0860	SWS 860	13/64 (5,16)	.380 (9,65)	1/16 (1,59)	.220 (5,59)	.148 (3,76)
12SWS0861	SWS 861	1/8 (3,18)	.378 (9,60)	1/32 (0,79)	.255 (6,48)	.116 (2,94)
12SWS0862	SWS 862	3/16 (4,76)	.390 (9,91)	5/64 (1,98)	.287 (7,29)	.196 (4,98)

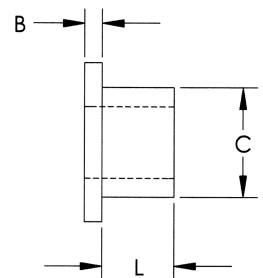
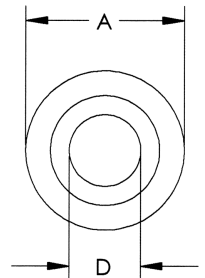



# WASHERS, SHOULDER WASHERS & SCREW INSULATORS

## SECTION IV

### NYLON SHOULDER WASHERS

Nylon Shoulder Washers are suitable for a large variety of insulation and mechanical applications.

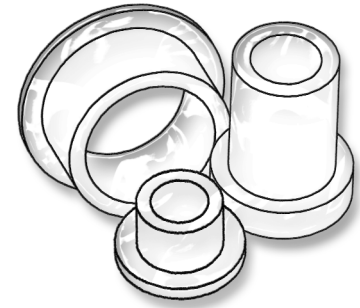

- ▶ THEY SEAL
- ▶ REDUCE VIBRATION
- ▶ ACT AS SPACERS AND GUIDES
- ▶ STRONG AND CORROSION RESISTANT

**New Sizes**

ITEM NUMBER	DESCRIPTION	L	A	B	C	D
12SWS0863	SWS 863	5/64 (1,98)	.390 (9,91)	5/64 (1,98)	.313 (7,95)	.203 (5,16)
12SWS0864	SWS 864	7/64 (2,77)	.395 (10,03)	5/64 (1,98)	.299 (7,59)	.230 (5,84)
12SWS0865	SWS 865	.055 (1,44)	.380 (9,65)	.065 (1,65)	.254 (6,45)	.196 (4,98)
12SWS0867	SWS 867	.046 (1,17)	.375 (9,53)	.040 (1,02)	.214 (5,44)	.141 (3,58)
12SWS0868	SWS 868	.031 (0,79)	.375 (9,53)	.062 (1,57)	.312 (7,92)	.253 (6,43)
12SWS0869	SWS 869	.207 (5,26)	.390 (9,91)	.062 (1,57)	.348 (8,84)	.312 (7,92)
12SWS0870	SWS 870	1/8 (3,18)	.433 (10,99)	1/16 (1,59)	.312 (7,92)	.199 (5,05)
12SWS0871	SWS 871	.130 (3,30)	.390 (9,91)	.062 (1,57)	.260 (6,60)	.200 (5,08)
12SWS0872	SWS 872	.160 (4,06)	27/64(10,72)	.050 (1,27)	9/32 (7,15)	.200 (5,08)
12SWS0873	SWS 873	.126 (3,20)	.394 (10,01)	.039 (0,99)	.256 (6,50)	.221 (5,61)
12SWS0874	SWS 874	.139 (3,53)	.390 (9,91)	.025 (0,63)	.303 (7,70)	.223 (5,66)
12SWS0875	SWS 875	.300 (7,62)	.375 (9,53)	.050 (1,27)	.253 (6,43)	.125 (3,18)
12SWS0876	SWS 876	.075 (1,91)	.390 (9,91)	.062 (1,57)	.260 (6,60)	.200 (5,08)
12SWS0877	SWS 877	.312 (7,92)	.390 (9,91)	.055 (1,40)	.281 (7,14)	.171 (4,34)
12SWS0878	SWS 878	.126 (3,20)	.394 (10,01)	.030 (0,76)	.256 (6,50)	.221 (5,61)
12SWS0879	SWS 879	.380 (9,65)	.385 (9,78)	.060 (1,52)	.236 (5,99)	.195 (4,95)
12SWS0880	SWS 880	1/8 (3,18)	.400 (10,16)	1/8 (3,18)	.275 (6,99)	.140 (3,56)
12SWS0881	SWS 881	.187 (4,75)	.312 (7,92)	.125 (3,18)	.250 (6,35)	.115 (2,92)
12SWS0882	SWS 882	9/32 (7,14)	.470 (11,93)	5/64 (1,98)	.312 (7,92)	.140 (3,56)
12SWS0883	SWS 883	.500 (12,70)	.407 (10,34)	.062 (1,57)	.260 (6,60)	.180 (4,57)
12SWS0884	SWS 884	.126 (3,20)	.394 (10,01)	.030 (0,76)	.275 (6,99)	.221 (5,61)
12SWS0885	SWS 885	.100 (1,54)	.400 (10,16)	1/8 (3,18)	.275 (6,99)	.140 (3,56)
12SWS0887	SWS 887	.187 (4,75)	.408 (10,36)	.062 (1,57)	.240 (6,10)	.197 (5,00)
12SWS0888	SWS 888	3/64 (1,19)	.400 (10,16)	3/64 (1,19)	.243 (6,17)	.156 (3,96)
12SWS0889	SWS 889	.420 (10,67)	.450 (11,43)	.125 (3,18)	.250 (6,35)	.195 (4,95)
12SWS0890	SWS 890	3/64 (1,19)	.415 (10,54)	5/32 (3,97)	.243 (6,17)	.141 (3,58)
12SWS0891	SWS 891	.058 (1,47)	.445 (11,30)	.077 (1,96)	.343 (8,71)	.308 (7,82)
12SWS0893	SWS 893	.075 (1,91)	.595 (15,11)	.062 (1,57)	.273 (6,93)	.170 (4,32)
12SWS0894	SWS 894	1/16 (1,59)	.418 (10,62)	7/64 (2,77)	.243 (6,17)	.141 (3,58)
12SWS0895	SWS 895	.050 (1,27)	.437 (11,10)	.062 (1,57)	.274 (6,96)	.199 (5,05)
12SWS0896	SWS 896	3/16 (4,76)	.408 (10,36)	1/16 (1,59)	.240 (6,10)	.220 (5,59)
12SWS0897	SWS 897	.315 (8,00)	.433 (11,00)	.079 (2,01)	.310 (7,87)	.202 (5,13)
12SWS0898	SWS 898	.050 (1,27)	.438 (11,13)	.062 (1,57)	.350 (8,89)	.125 (3,18)
12SWS0900	SWS 900	1/32 (0,79)	.428 (10,87)	1/16 (1,59)	.245 (6,22)	.156 (3,96)
12SWS0901	SWS 901	.093 (2,36)	.437 (11,10)	.040 (1,02)	.375 (9,53)	.194 (4,93)
12SWS0902	SWS 902	1/32 (0,79)	.437 (11,10)	1/16 (1,59)	.245 (6,22)	.156 (3,96)
12SWS0903	SWS 903	.115 (2,92)	.432 (10,97)	.065 (1,65)	.256 (6,50)	.196 (4,98)
12SWS0904	SWS 904	3/8 (9,53)	.437 (11,10)	1/16 (1,59)	.282 (7,16)	.225 (5,72)
12SWS0905	SWS 905	1/16 (1,59)	.425 (10,78)	1/16 (1,59)	.310 (7,87)	.250 (6,35)
12SWS0906	SWS 906	.035 (0,89)	.625 (15,87)	.050 (1,27)	.427 (10,84)	.170 (4,32)
12SWS0907	SWS 907	.026 (0,66)	.438 (11,13)	.094 (2,39)	.307 (7,80)	.253 (6,43)
12SWS0908	SWS 908	3/32 (2,38)	.438 (11,13)	1/32 (0,79)	.267 (6,78)	.203 (5,16)
12SWS0909	SWS 909	13/32 (10,32)	.493 (12,52)	3/32 (2,38)	.376 (9,55)	.176 (4,47)
12SWS0910	SWS 910	.070 (1,78)	.443 (11,25)	.048 (1,22)	.285 (7,24)	.191 (4,85)
12SWS0911	SWS 911	.048 (1,22)	.428 (10,87)	.155 (3,94)	.261 (6,63)	.163 (4,14)

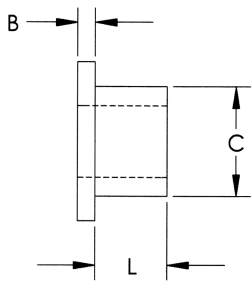
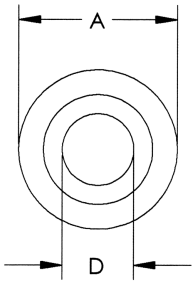

# WASHERS, SHOULDER WASHERS & SCREW INSULATORS

SECTION  
IV

## NYLON SHOULDER WASHERS

Nylon Shoulder Washers are suitable for a large variety of insulation and mechanical applications.

- ▶ THEY SEAL
- ▶ REDUCE VIBRATION
- ▶ ACT AS SPACERS AND GUIDES
- ▶ STRONG AND CORROSION RESISTANT

**New Sizes**

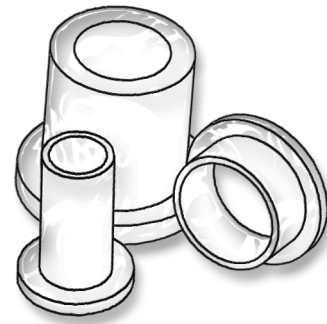

ITEM NUMBER	DESCRIPTION	L	A	B	C	D
12SWS0912	SWS 912	9/64 (3,58)	.432 (10,97)	1/32 (0,79)	.303 (7,70)	.196 (4,98)
12SWS0914	SWS 914	.043 (1,09)	.440 (11,18)	.094 (2,39)	.312 (7,92)	.193 (4,90)
12SWS0915	SWS 915	.138 (3,51)	.413 (10,49)	.315 (8,00)	.244 (6,20)	.217 (5,51)
12SWS0916	SWS 916	3/16 (4,76)	.743 (18,87)	1/16 (1,59)	.437 (11,10)	.376 (9,55)
12SWS0917	SWS 917	3/64 (1,19)	.428 (10,87)	1/8 (3,18)	.350 (8,89)	.308 (7,82)
12SWS0918	SWS 918	3/64 (1,19)	.450 (11,43)	1/64 (0,41)	.310 (7,87)	.230 (5,84)
12SWS0919	SWS 919	.060 (1,52)	.460 (11,68)	.030 (0,76)	.370 (9,40)	.260 (6,60)
12SWS0920	SWS 920	.138 (3,51)	.413 (10,49)	.118 (3,00)	.244 (6,20)	.217 (5,51)
12SWS0921	SWS 921	.236 (5,99)	.480 (12,19)	.079 (2,01)	.315 (8,00)	.240 (6,10)
12SWS0922	SWS 922	.280 (7,11)	.450 (11,43)	.047 (1,19)	.170 (4,32)	.140 (3,56)
12SWS0925	SWS 925	3/64 (1,19)	.468 (11,89)	1/16 (1,59)	.248 (6,30)	.140 (3,56)
12SWS0926	SWS 926	11/16 (17,53)	.498 (12,64)	1/16 (1,59)	.375 (9,53)	.254 (6,45)
12SWS0930	SWS 930	7/32 (5,55)	.468 (11,89)	3/64 (1,19)	.375 (9,53)	.325 (8,26)
12SWS0933	SWS 933	.125 (3,18)	.450 (11,43)	.065 (1,65)	.310 (7,87)	.260 (6,60)
12SWS0935	SWS 935	.187 (4,75)	.495 (12,57)	.065 (1,65)	.312 (7,92)	.200 (5,08)
12SWS0940	SWS 940	.157 (3,99)	.483 (12,27)	.059 (1,50)	.315 (8,00)	.240 (6,10)
12SWS0950	SWS 950	.157 (3,99)	.472 (11,99)	.181 (4,60)	.315 (8,00)	.205 (5,21)
12SWS0951	SWS 951	.031 (0,79)	.500 (12,70)	.031 (0,79)	.243 (6,17)	.171 (4,34)
12SWS0952	SWS 952	.099 (2,51)	.500 (12,70)	.096 (2,44)	.373 (9,47)	.194 (4,93)
12SWS0953	SWS 953	.187 (4,75)	.500 (12,70)	.062 (1,57)	.307 (7,80)	.265 (6,73)
12SWS0954	SWS 954	.085 (2,16)	.500 (12,70)	.039 (0,99)	.234 (5,94)	.195 (4,95)
12SWS0955	SWS 955	.080 (2,03)	.500 (12,70)	.118 (3,00)	.213 (5,41)	.145 (3,68)
12SWS0968	SWS 968	.748 (19,00)	.698 (17,73)	.065 (1,65)	.400 (10,16)	.316 (8,03)
12SWS0969	SWS 969	.335 (8,51)	.551 (14,00)	.059 (1,50)	.413 (10,49)	.335 (8,51)
12SWS0970	SWS 970	.200 (5,08)	.500 (12,70)	.105 (2,67)	.245 (6,22)	.171 (4,34)
12SWS1000	SWS 1000	.240 (6,10)	.563 (14,30)	.068 (1,73)	.443 (11,25)	.320 (8,13)
12SWS1001	SWS 1001	3/8 (9,53)	.399 (10,13)	1/16 (1,59)	.260 (6,60)	.200 (5,08)
12SWS1002	SWS 1002	3/32 (2,38)	.438 (11,13)	1/16 (1,59)	.267 (6,78)	.203 (5,16)
12SWS1003	SWS 1003	3/16 (4,76)	.745 (18,92)	1/32 (0,79)	.282 (7,16)	.234 (5,94)
12SWS1004	SWS 1004	9/64 (3,58)	.438 (11,13)	1/32 (0,79)	.250 (6,35)	.135 (3,43)
12SWS1005	SWS 1005	5/64 (1,98)	.464 (11,79)	1/64 (0,41)	.312 (7,92)	.255 (6,48)
12SWS1006	SWS 1006	11/64 (4,37)	.425 (10,80)	1/16 (1,59)	.377 (9,58)	.260 (6,60)
12SWS1007	SWS 1007	3/64 (1,19)	.437 (11,10)	3/64 (1,19)	.281 (7,14)	.201 (5,11)
12SWS1008	SWS 1008	3/64 (1,19)	.620 (15,75)	3/64 (1,19)	.312 (7,92)	.205 (5,21)
12SWS1009	SWS 1009	1/16 (1,59)	.740 (18,80)	1/32 (0,79)	.368 (9,53)	.320 (8,13)
12SWS1010	SWS 1010	3/64 (1,19)	.625 (15,88)	7/64 (2,77)	.375 (9,53)	.250 (6,35)
12SWS1011	SWS 1011	1/16 (1,59)	.675 (17,14)	3/32 (2,38)	.480 (12,19)	.257 (6,53)
12SWS1012	SWS 1012	1/8 (3,18)	.697 (17,70)	1/16 (1,59)	.359 (9,12)	.266 (6,76)
12SWS1013	SWS 1013	3/64 (1,19)	.688 (17,48)	1/32 (0,79)	.543 (13,79)	.508 (12,90)
12SWS1014	SWS 1014	1/32 (0,79)	.437 (11,10)	1/32 (0,79)	.310 (7,87)	.253 (6,43)
12SWS1015	SWS 1015	3/64 (1,19)	.500 (12,70)	3/32 (2,38)	.275 (6,99)	.145 (3,68)
12SWS1016	SWS 1016	7/16 (11,11)	.500 (12,70)	1/8 (3,18)	.250 (6,35)	.167 (4,24)
12SWS1017	SWS 1017	1/16 (1,59)	.562 (14,27)	3/32 (2,38)	.375 (9,53)	.260 (6,60)
12SWS1018	SWS 1018	3/16 (4,76)	.625 (15,88)	1/16 (1,59)	.322 (8,18)	.255 (6,48)
12SWS1019	SWS 1019	3/64 (1,19)	.615 (15,62)	1/32 (0,79)	.310 (7,87)	.253 (6,43)

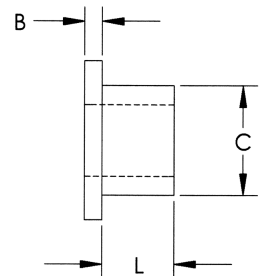
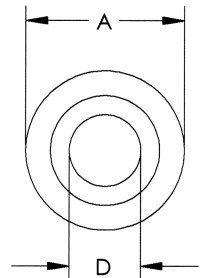

# WASHERS, SHOULDER WASHERS & SCREW INSULATORS

## SECTION IV

### NYLON SHOULDER WASHERS

Nylon Shoulder Washers are suitable for a large variety of insulation and mechanical applications.

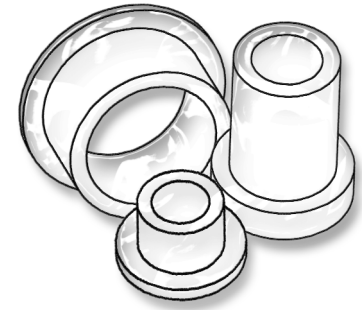

**New Sizes**

- ▶ THEY SEAL
- ▶ REDUCE VIBRATION
- ▶ ACT AS SPACERS AND GUIDES
- ▶ STRONG AND CORROSION RESISTANT

ITEM NUMBER	DESCRIPTION	L	A	B	C	D
12SWS1020	SWS 1020	1/16 (1,59)	.640 (16,26)	1/16 (1,59)	.380 (9,65)	.195 (4,95)
12SWS1021	SWS 1021	3/64 (1,19)	.630 (16,00)	1/32 (0,79)	.248 (6,30)	.171 (4,34)
12SWS1022	SWS 1022	3/64 (1,19)	.625 (15,88)	1/16 (1,59)	.375 (9,53)	.190 (4,83)
12SWS1023	SWS 1023	3/64 (1,19)	.555 (14,10)	5/64 (1,98)	.300 (7,62)	.260 (6,60)
12SWS1024	SWS 1024	1/2 (12,70)	.620 (15,75)	.031 (0,79)	.370 (9,40)	.316 (8,03)
12SWS1025	SWS 1025	7/16 (11,11)	9/16 (14,28)	1/16 (1,59)	.375 (9,53)	.255 (6,48)
12SWS1026	SWS 1026	1/32 (0,79)	.588 (14,93)	1/32 (0,79)	.253 (6,43)	.198 (5,02)
12SWS1027	SWS 1027	1/2 (12,70)	.500 (12,70)	1/16 (1,59)	.365 (9,27)	.312 (7,92)
12SWS1028	SWS 1028	.249 (6,32)	.500 (12,70)	.062 (1,57)	.250 (6,35)	.189 (4,80)
12SWS1029	SWS 1029	.158 (4,01)	.500 (12,70)	.120 (3,05)	.300 (7,62)	.196 (4,98)
12SWS1030	SWS 1030	3/32 (2,38)	.490 (12,45)	1/16 (1,59)	.281 (7,14)	.200 (5,08)
12SWS1031	SWS 1031	.050 (1,27)	.500 (12,70)	.062 (1,57)	.248 (6,30)	.194 (4,93)
12SWS1032	SWS 1032	1/32 (0,79)	.500 (12,70)	3/32 (2,38)	.250 (6,35)	.156 (3,96)
12SWS1033	SWS 1033	5/16 (7,94)	.500 (12,70)	1/16 (1,59)	.312 (7,92)	.200 (5,08)
12SWS1034	SWS 1034	1/32 (0,79)	.500 (12,70)	1/32 (0,79)	.312 (7,92)	.252 (6,40)
12SWS1035	SWS 1035	1/32 (0,79)	.500 (12,70)	1/16 (1,59)	.230 (5,84)	.147 (3,73)
12SWS1036	SWS 1036	1/64 (0,41)	.500 (12,70)	5/64 (1,98)	.250 (6,35)	.165 (4,19)
12SWS1037	SWS 1037	.047 (1,19)	.500 (12,70)	.125 (3,17)	.281 (7,14)	.219 (5,56)
12SWS1038	SWS 1038	1.000 (25,40)	.875 (22,23)	.062 (1,57)	.500 (12,70)	.390 (9,91)
12SWS1039	SWS 1039	.310 (7,87)	.630 (16,0)	.070 (1,78)	.265 (6,73)	.184 (4,67)
12SWS1040	SWS 1040	3/32 (2,38)	.505 (12,83)	1/16 (1,59)	.343 (8,71)	.257 (6,53)
12SWS1041	SWS 1041	.335 (8,51)	.495 (12,57)	.050 (1,27)	.346 (8,79)	.260 (6,60)
12SWS1042	SWS 1042	.027 (0,69)	.500 (12,70)	.031 (0,79)	.248 (6,30)	.199 (5,05)
12SWS1044	SWS 1044	.080 (2,03)	.500 (12,70)	.078 (1,98)	.213 (5,41)	.145 (3,68)
12SWS1045	SWS 1045	3/16 (4,76)	.498 (12,65)	1/4 (6,35)	.310 (7,87)	.195 (4,95)
12SWS1046	SWS 1046	.150 (3,81)	.504 (12,80)	.160 (4,06)	.312 (7,92)	.265 (6,73)
12SWS1047	SWS 1047	1.250 (31,75)	.500 (12,70)	.125 (3,18)	.375 (9,53)	.250 (6,35)
12SWS1048	SWS 1048	7/16 (11,11)	.500 (12,70)	1/16 (1,59)	.375 (9,53)	.250 (6,35)
12SWS1049	SWS 1049	.076 (1,93)	.500 (12,70)	.040 (1,02)	.345 (8,76)	.265 (6,73)
12SWS1050	SWS 1050	5/32 (3,97)	.490 (12,45)	1/16 (1,59)	.250 (6,35)	.190 (4,83)
12SWS1051	SWS 1051	3/64 (1,19)	.441 (11,20)	1/16 (1,59)	.248 (6,30)	.194 (4,92)
12SWS1052	SWS 1052	5/32 (3,97)	.488 (12,39)	1/8 (3,18)	.250 (6,35)	.190 (4,83)
12SWS1053	SWS 1053	.170 (4,32)	.500 (12,70)	.125 (3,17)	.375 (9,52)	.257 (6,53)
12SWS1054	SWS 1054	9/64 (3,58)	.500 (12,70)	1/16 (1,59)	.345 (8,76)	.285 (7,34)
12SWS1055	SWS 1055	1/32 (0,79)	.495 (12,57)	1/32 (0,79)	.312 (7,92)	.260 (6,60)
12SWS1056	SWS 1056	.050 (1,27)	.500 (12,70)	.063 (1,60)	.265 (6,73)	.169 (4,29)
12SWS1057	SWS 1057	3/32 (2,38)	.505 (12,83)	1/16 (1,59)	.312 (7,92)	.260 (6,60)
12SWS1058	SWS 1058	1/32 (0,79)	.490 (12,45)	1/32 (0,79)	.310 (7,87)	.193 (4,90)
12SWS1059	SWS 1059	.060 (1,52)	.500 (12,70)	.030 (0,76)	.365 (9,27)	.260 (6,60)
12SWS1060	SWS 1060	5/64 (1,98)	.492 (12,50)	1/32 (0,79)	.318 (8,08)	.265 (6,73)
12SWS1061	SWS 1061	5/32 (3,97)	.488 (12,39)	1/8 (3,18)	.250 (6,35)	.215 (5,46)
12SWS1062	SWS 1062	.075 (1,91)	.500 (12,70)	.063 (1,60)	.265 (6,73)	.169 (4,29)
12SWS1063	SWS 1063	.460 (11,68)	.450 (11,43)	.125 (3,17)	.250 (6,35)	.195 (4,95)
12SWS1065	SWS 1065	3/16 (4,76)	.513 (13,03)	1/16 (1,59)	.312 (7,92)	.175 (4,45)
12SWS1069	SWS 1069	.630 (16,00)	.492 (12,50)	.055 (1,40)	.370 (9,40)	.315 (8,00)

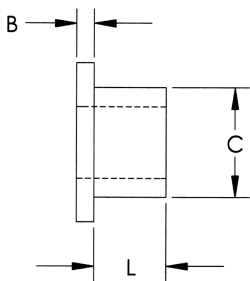
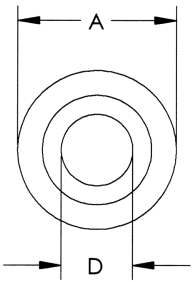

## NYLON SHOULDER WASHERS

Nylon Shoulder Washers are suitable for a large variety of insulation and mechanical applications.

- ▶ THEY SEAL
- ▶ REDUCE VIBRATION
- ▶ ACT AS SPACERS AND GUIDES
- ▶ STRONG AND CORROSION RESISTANT

**New Sizes**

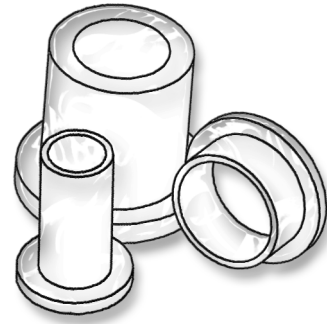

ITEM NUMBER	DESCRIPTION	L	A	B	C	D
12SWS1070	SWS 1070	5/64 (1,98)	.500 (12,70)	1/32 (0,79)	.318 (8,08)	.193 (4,90)
12SWS1071	SWS 1071	.253 (6,43)	.502 (12,75)	.187 (4,75)	.374 (9,50)	.318 (8,08)
12SWS1075	SWS 1075	1/4 (6,35)	.513 (13,03)	1/16 (1,59)	.370 (9,40)	.260 (6,60)
12SWS1079	SWS 1079	.122 (3,10)	.500 (12,70)	.167 (4,24)	.270 (6,86)	.222 (5,64)
12SWS1080	SWS 1080	1/64 (0,41)	.500 (12,70)	1/32 (0,79)	.318 (8,08)	.141 (3,58)
12SWS1081	SWS 1081	.375 (9,53)	.500 (12,70)	.093 (2,36)	.411 (10,44)	.380 (9,65)
12SWS1082	SWS 1082	3/64 (1,19)	.500 (12,70)	1/32 (0,79)	.318 (8,08)	.193 (4,90)
12SWS1083	SWS 1083	.160 (4,06)	1/2 (12,70)	.062 (1,57)	.360 (9,14)	.260 (6,60)
12SWS1084	SWS 1084	3/64 (1,19)	.500 (12,70)	1/32 (0,79)	.318 (8,08)	.141 (3,58)
12SWS1086	SWS 1086	1/16 (1,59)	.500 (12,70)	1/16 (1,59)	.330 (8,38)	.150 (3,81)
12SWS1088	SWS 1088	.109 (2,77)	.500 (12,70)	1/16 (1,59)	.240 (6,10)	.138 (3,51)
12SWS1090	SWS 1090	3/64 (1,19)	.518 (13,16)	1/32 (0,79)	.305 (7,75)	.080 (2,03)
12SWS1092	SWS 1092	.075 (1,91)	.500 (12,70)	.175 (4,45)	.300 (7,62)	.195 (4,95)
12SWS1095	SWS 1095	1/8 (3,18)	.502 (12,75)	1/32 (0,79)	.399 (10,13)	.349 (8,86)
12SWS1096	SWS 1096	*.375 (9,53)	*.437 (11,10)	.055 (1,40)	*.310 (7,87)	*.196 (4,98)
12SWS1098	SWS 1098	9/64 (3,58)	.515 (13,08)	1/16 (1,59)	.312 (7,93)	.260 (6,60)
12SWS1100	SWS 1100	15/16 (23,81)	.540 (13,72)	.065 (1,65)	.370 (9,40)	.260 (6,60)
12SWS1101	SWS 1101	3/32 (2,38)	.500 (12,70)	1/32 (0,79)	.282 (7,16)	.234 (5,94)
12SWS1115	SWS 1115	.500 (12,70)	.525 (15,88)	.063 (1,60)	.370 (9,40)	.267 (6,78)
12SWS1145	SWS 1145	.030 (0,76)	.562 (14,28)	.030 (0,76)	.400 (10,16)	.318 (8,08)
12SWS1149	SWS 1149	.188 (4,78)	.562 (14,27)	.731 (18,57)	.388 (9,86)	.290 (7,37)
12SWS1150	SWS 1150	3/64 (1,19)	.562 (14,28)	3/64 (1,19)	.300 (7,62)	.260 (6,60)
12SWS1151	SWS 1151	.104 (2,64)	.562 (14,28)	.046 (1,17)	.300 (7,62)	.260 (6,60)
12SWS1152	SWS 1152	.500 (12,70)	.525 (13,33)	.063 (1,60)	.370 (9,40)	.265 (6,73)
12SWS1153	SWS 1153	.040 (1,02)	.560 (14,22)	.060 (1,52)	.312 (7,92)	.257 (6,53)
12SWS1154	SWS 1154	.050 (1,27)	.516 (13,11)	.060 (1,52)	.345 (8,76)	.260 (6,60)
12SWS1155	SWS 1155	3/64 (1,19)	.562 (14,28)	.024 (0,61)	.370 (9,40)	.335 (8,51)
12SWS1156	SWS 1156	.050 (1,27)	.515 (13,08)	.039 (0,99)	.338 (8,59)	.260 (6,60)
12SWS1159	SWS 1159	9/16 (14,29)	.550 (13,97)	1/16 (1,59)	.375 (9,53)	.255 (6,48)
12SWS1160	SWS 1160	1/16 (1,59)	.562 (14,28)	7/64 (2,77)	.365 (9,27)	.215 (5,46)
12SWS1161	SWS 1161	.620 (15,75)	9/16 (14,27)	1/16 (1,57)	.395 (10,03)	.355 (9,02)
12SWS1162	SWS 1162	27/64 (10,72)	.560 (14,22)	1/16 (1,59)	.375 (9,53)	.255 (6,48)
12SWS1163	SWS 1163	15/32 (11,91)	.550 (13,97)	1/16 (1,59)	.380 (9,65)	.247 (6,27)
12SWS1164	SWS 1164	1/32 (0,79)	.562 (14,28)	1/8 (3,18)	.312 (7,93)	.169 (4,29)
12SWS1165	SWS 1165	1/4 (6,35)	.551 (13,99)	1/16 (1,59)	.380 (9,65)	.248 (6,30)
12SWS1167	SWS 1167	.128 (3,25)	.591 (15,01)	.197 (5,00)	.394 (10,01)	.157 (3,99)
12SWS1170	SWS 1170	3/8 (9,53)	.570 (14,48)	1/16 (1,59)	.470 (11,94)	.385 (9,78)
12SWS1171	SWS 1171	.060 (1,52)	.625 (15,87)	.045 (1,14)	.470 (11,94)	.345 (8,76)
12SWS1175	SWS 1175	.783 (19,89)	.570 (14,48)	.039 (0,99)	.491 (12,47)	.413 (10,49)
12SWS1176	SWS 1176	.335 (8,51)	.545 (13,84)	.075 (1,91)	.316 (8,03)	.166 (4,22)
12SWS1177	SWS 1177	.110 (2,79)	.571 (14,50)	.074 (6,88)	.526 (13,36)	.441 (11,20)
12SWS1178	SWS 1178	.126 (3,20)	.598 (15,19)	.070 (1,78)	.477 (12,12)	.372 (9,45)
12SWS1180	SWS 1180	3/64 (1,19)	.578 (14,68)	1/16 (1,59)	.185 (4,70)	.140 (3,56)
12SWS1197	SWS 1197	.342 (8,69)	.625 (15,88)	.125 (3,18)	.485 (12,32)	.390 (9,91)
12SWS1198	SWS 1198	.093 (2,36)	.620 (15,75)	.063 (1,60)	.360 (9,14)	.320 (8,13)

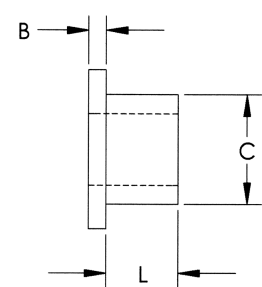
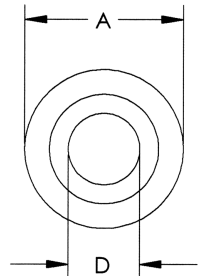

\* +/- .010



# WASHERS, SHOULDER WASHERS & SCREW INSULATORS

## SECTION IV

### NYLON SHOULDER WASHERS

Nylon Shoulder Washers are suitable for a large variety of insulation and mechanical applications.

- ▶ THEY SEAL
- ▶ REDUCE VIBRATION
- ▶ ACT AS SPACERS AND GUIDES
- ▶ STRONG AND CORROSION RESISTANT

**New Sizes**

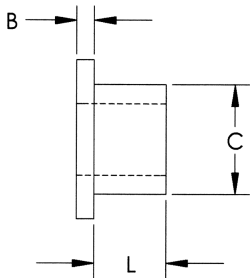
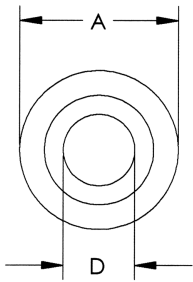
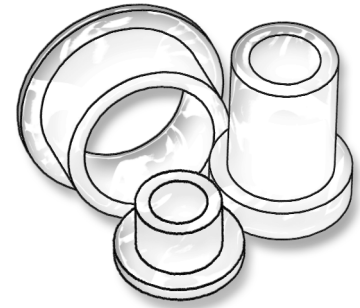

ITEM NUMBER	DESCRIPTION	L	A	B	C	D
12SWS1199	SWS 1199	.100 (2,54)	.620 (15,75)	.062 (1,57)	.400 (10,16)	.260 (6,60)
12SWS1200	SWS 1200	3/64 (1,19)	.615 (15,62)	3/64 (1,19)	.315 (8,00)	.208 (5,28)
12SWS1201	SWS 1201	1/8 (3,18)	.620 (15,75)	3/8 (9,53)	.360 (9,14)	.320 (8,13)
12SWS1204	SWS 1204	.500 (12,70)	.600 (15,24)	.025 (0,64)	.485 (12,32)	.324 (8,23)
12SWS1205	SWS 1205	1/32 (0,79)	.620 (15,75)	3/64 (1,19)	.434 (11,02)	.383 (9,73)
12SWS1207	SWS 1207	.163 (4,14)	.625 (15,88)	.040 (1,02)	.281 (7,14)	.219 (5,56)
12SWS1208	SWS 1208	.100 (2,54)	.620 (15,75)	.060 (1,52)	.502 (12,75)	.316 (8,03)
12SWS1210	SWS 1210	1/32 (0,79)	.625 (15,88)	1/16 (1,59)	.495 (12,57)	.378 (9,60)
12SWS1211	SWS 1211	.139 (3,53)	.625 (15,88)	.066 (1,68)	.405 (10,29)	.320 (8,13)
12SWS1212	SWS 1212	.025 (0,64)	.625 (15,88)	.062 (1,57)	.375 (9,53)	.200 (5,08)
12SWS1213	SWS 1213	.031 (0,79)	.625 (15,88)	.031 (0,79)	.437 (11,10)	.380 (9,65)
12SWS1214	SWS 1214	.150 (3,81)	.630 (16,00)	.050 (1,27)	.375 (9,53)	.280 (7,11)
12SWS1215	SWS 1215	.062 (1,57)	.625 (15,88)	1/32 (0,79)	.310 (7,87)	.195 (4,95)
12SWS1217	SWS 1217	.030 (0,76)	.625 (15,88)	.030 (0,76)	.447 (12,12)	.378 (9,60)
12SWS1219	SWS 1219	3/64 (1,19)	.625 (15,88)	1/16 (1,59)	.310 (7,87)	.172 (4,37)
12SWS1220	SWS 1220	3/4 (19,05)	.620 (15,75)	1/8 (3,18)	.400 (10,60)	.260 (6,60)
12SWS1221	SWS 1221	1/8 (3,18)	.630 (16,00)	1/16 (1,59)	.327 (8,31)	.260 (6,60)
12SWS1222	SWS 1222	1/32 (0,79)	.625 (15,88)	1/32 (0,79)	.448 (11,37)	.378 (9,60)
12SWS1225	SWS 1225	.027 (0,69)	.625 (15,88)	.062 (1,57)	.248 (6,30)	.120 (3,05)
12SWS1227	SWS 1227	.210 (5,33)	.625 (15,88)	.058 (1,47)	.379 (9,63)	.263 (6,68)
12SWS1228	SWS 1228	.025 (0,64)	.625 (15,88)	.060 (1,52)	.219 (5,56)	.140 (3,56)
12SWS1230	SWS 1230	3/64 (1,19)	.550 (13,97)	5/64 (1,98)	.305 (7,75)	.260 (6,60)
12SWS1232	SWS 1232	1/2 (12,70)	.620 (15,75)	1/16 (1,59)	.370 (9,40)	.316 (8,03)
12SWS1233	SWS 1233	.090 (2,29)	.625 (15,88)	.062 (1,57)	.311 (7,90)	.253 (6,43)
12SWS1235	SWS 1235	.150 (3,81)	.620 (15,75)	.060 (1,52)	.502 (12,75)	.316 (8,03)
12SWS1239	SWS 1239	.188 (4,78)	.625 (15,88)	.032 (0,81)	.260 (6,60)	.200 (5,08)
12SWS1240	SWS 1240	3/16 (4,76)	.630 (16,00)	1/16 (1,59)	.375 (9,53)	.254 (6,45)
12SWS1241	SWS 1241	.175 (4,45)	.650 (16,51)	.125 (3,18)	.490 (12,45)	.385 (9,78)
12SWS1242	SWS 1242	.563 (14,30)	.625 (15,88)	.125 (3,18)	.485 (12,32)	.390 (9,91)
12SWS1243	SWS 1243	.748 (19,00)	.630 (16,00)	.055 (1,40)	.500 (12,70)	.437 (11,10)
12SWS1244	SWS 1244	.090 (2,29)	.635 (16,13)	.042 (1,07)	.380 (9,65)	.216 (5,49)
12SWS2102	SWS 2102	.220 (5,59)	.620 (15,75)	.057 (1,45)	.366 (9,30)	.310 (7,87)
12SWS2496	SWS 2496	.150 (3,81)	.343 (8,71)	.263 (6,68)	.232 (5,89)	.130 (3,30)
12SWS2497	SWS 2497	.150 (3,81)	.343 (8,71)	.340 (8,64)	.232 (5,89)	.130 (3,30)
12SWS2498	SWS 2498	.513 (13,03)	.687 (17,44)	.263 (6,68)	.412 (10,46)	.325 (8,26)
12SWS2499	SWS 2499	3/8 (9,53)	.513 (13,03)	1/16 (1,59)	.312 (7,93)	.191 (4,85)
12SWS2500	SWS 2500	1/32 (7,94)	.500 (12,70)	3/32 (2,38)	.250 (6,35)	.156 (3,96)
12SWS2501	SWS 2501	3/8 (9,53)	.513 (13,03)	1/16 (1,59)	.312 (7,93)	.261 (6,63)
12SWS2502	SWS 2502	1/8 (3,18)	.467 (11,86)	3/64 (1,19)	.312 (7,93)	.255 (6,48)
12SWS2503	SWS 2503	1/32 (0,79)	.625 (15,88)	1/16 (1,59)	.375 (9,53)	.295 (7,49)
12SWS2504	SWS 2504	1/8 (3,18)	.687 (17,45)	1/8 (3,18)	.437 (11,10)	.328 (8,33)
12SWS2505	SWS 2505	1/32 (0,79)	.500 (12,70)	1/16 (1,59)	.312 (7,93)	.252 (6,40)
12SWS2506	SWS 2506	5/16 (7,94)	.625 (15,88)	1/16 (1,59)	.500 (12,70)	.380 (9,65)
12SWS2507	SWS 2507	1/8 (3,18)	.600 (15,24)	1/8 (3,18)	.370 (7,93)	.250 (6,35)
12SWS2508	SWS 2508	3/16 (4,76)	.674 (17,12)	3/32 (2,38)	.500 (12,70)	.290 (7,36)



# WASHERS, SHOULDER WASHERS & SCREW INSULATORS

SECTION  
IV

## NYLON SHOULDER WASHERS

Nylon Shoulder Washers are suitable for a large variety of insulation and mechanical applications.

- ▶ THEY SEAL
- ▶ REDUCE VIBRATION
- ▶ ACT AS SPACERS AND GUIDES
- ▶ STRONG AND CORROSION RESISTANT

New Sizes

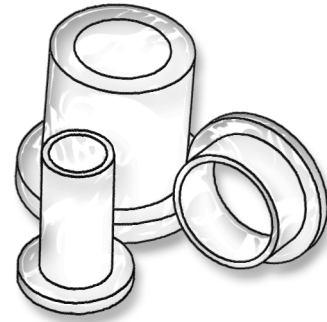

ITEM NUMBER	DESCRIPTION	L	A	B	C	D
12SWS2509	SWS 2509	1-7/64 (28,17)	.635 (16,13)	9/64 (3,58)	.425 (10,80)	.201 (5,11)
12SWS2510	SWS 2510	3/8 (9,53)	.687 (17,45)	3/8 (9,53)	.359 (9,12)	.263 (6,68)
12SWS2511	SWS 2511	5/16 (7,94)	.625 (15,88)	1/16 (1,59)	.500 (12,70)	.395 (10,03)
12SWS2512	SWS 2512	.334 (8,48)	.687 (17,45)	.046 (1,17)	.348 (8,84)	.263 (6,68)
12SWS2513	SWS 2513	1/8 (3,18)	.703 (17,86)	1/16 (1,59)	.437 (11,10)	.335 (8,51)
12SWS2515	SWS 2515	.420 (10,67)	.710 (18,03)	.075 (1,90)	.470 (11,94)	.420 (10,67)
12SWS2516	SWS 2516	.280 (7,11)	.701 (17,80)	.062 (1,57)	.305 (7,75)	.258 (6,55)
12SWS2517	SWS 2517	.110 (2,79)	.710 (18,03)	.190 (4,83)	.338 (8,59)	.255 (6,48)
12SWS2518	SWS 2518	.146 (3,71)	.692 (17,58)	.051 (1,30)	.417 (10,59)	.249 (6,32)
12SWS2519	SWS 2519	.145 (3,68)	.736 (18,69)	.125 (3,18)	.371 (9,42)	.168 (4,27)
12SWS2520	SWS 2520	5/32 (3,97)	.725 (18,41)	5/32 (3,97)	.445 (11,30)	.375 (9,53)
12SWS2521	SWS 2521	5/32 (3,97)	.720 (18,29)	1/16 (1,59)	.485 (12,32)	.270 (6,86)
12SWS2522	SWS 2522	.187 (4,75)	.700 (17,78)	.225 (5,72)	.375 (9,53)	.268 (6,81)
12SWS2524	SWS 2524	.150 (3,81)	.730 (18,54)	.125 (3,18)	.500 (12,70)	.315 (8,00)
12SWS2525	SWS 2525	11/32 (3,43)	.730 (18,54)	1/4 (6,35)	.375 (9,53)	.257 (6,52)
12SWS2526	SWS 2526	.500 (12,70)	.688 (17,48)	.062 (1,58)	.562 (14,27)	.437 (11,10)
12SWS2528	SWS 2528	3/16 (4,76)	.743 (18,87)	1/16 (1,59)	.443 (11,25)	.375 (9,53)
12SWS2529	SWS 2529	19/32 (15,08)	.750 (19,05)	.060 (1,52)	.528 (13,41)	.385 (9,78)
12SWS2531	SWS 2531	5/16 (7,94)	.743 (18,87)	5/64 (1,98)	.502 (12,75)	.383 (9,72)
12SWS2532	SWS 2532	.155 (3,94)	.745 (18,92)	.100 (2,54)	.545 (13,84)	.391 (9,93)
12SWS2533	SWS 2533	.375 (9,52)	3/4 (19,05)	.375 (9,52)	.594 (15,09)	.380 (9,65)
12SWS2534	SWS 2534	.187 (4,75)	.745 (18,92)	.031 (0,79)	.282 (7,16)	.234 (5,94)
12SWS2535	SWS 2535	.118 (3,00)	.750 (19,05)	.032 (0,81)	.688 (17,48)	.569 (14,45)
12SWS2536	SWS 2536	.031 (0,79)	.750 (19,05)	.062 (1,58)	.500 (12,70)	.375 (9,53)
12SWS2538	SWS 2538	1/8 (3,18)	3/4 (19,05)	1/16 (1,59)	.469 (11,91)	.344 (8,74)
12SWS2539	SWS 2539	11/32 (8,73)	.740 (18,80)	3/32 (2,38)	.375 (9,53)	.266 (6,76)
12SWS2540	SWS 2540	1/8 (3,18)	.740 (18,80)	3/32 (2,38)	.371 (9,42)	.266 (6,76)
12SWS2541	SWS 2541	5/64 (1,98)	.750 (19,05)	3/32 (2,38)	.380 (9,65)	.266 (6,76)
12SWS2542	SWS 2542	3/64 (1,19)	.750 (19,05)	3/16 (4,76)	.500 (12,70)	.430 (10,92)
12SWS2543	SWS 2543	.779 (19,79)	.750 (19,05)	.095 (2,41)	.490 (12,45)	.189 (4,80)
12SWS2544	SWS 2544	1.00 (25,40)	.75 (19,05)	.095 (2,41)	.375 (9,53)	.265 (6,73)
12SWS2545	SWS 2545	.100 (2,54)	3/4 (19,05)	.086 (2,18)	.500 (12,70)	.250 (6,35)
12SWS2546	SWS 2546	.125 (3,18)	.750 (19,05)	.187 (4,75)	.500 (12,70)	.344 (8,74)
12SWS2547	SWS 2547	.250 (6,35)	.750 (19,05)	.062 (1,57)	.617 (15,67)	.509 (12,93)
12SWS2548	SWS 2548	.425 (10,80)	.750 (19,05)	1/16" (1,59)	.590 (14,99)	.375 (9,53)
12SWS2549	SWS 2549	.140 (3,56)	.750 (19,05)	.031 (0,79)	.708 (17,98)	.630 (16,00)
12SWS2550	SWS 2550	1/16 (1,59)	.734 (18,64)	1/8" (3,18)	.488 (12,40)	.250 (6,35)
12SWS2551	SWS 2551	3/64 (1,19)	.753 (19,12)	5/64 (1,98)	.409 (10,38)	.258 (6,55)
12SWS2552	SWS 2552	7/64 (2,77)	.743 (18,87)	3/32 (2,38)	.500 (12,70)	.375 (9,53)
12SWS2553	SWS 2553	5/16 (7,94)	.750 (19,05)	5/64 (1,98)	.500 (12,70)	.370 (9,39)
12SWS2554	SWS 2554	3/64 (1,19)	.735 (18,67)	3/16 (4,76)	.490 (12,45)	.435 (11,05)
12SWS2555	SWS 2555	.098 (2,49)	.747 (18,87)	.079 (2,01)	.482 (12,24)	.358 (9,09)
12SWS2556	SWS 2556	3/16 (4,76)	.750 (19,05)	1/16 (1,59)	.500 (12,70)	.375 (9,53)
12SWS2557	SWS 2557	23/64 (10,00)	.748 (18,99)	1/8 (3,18)	.504 (12,80)	.384 (9,75)
12SWS2558	SWS 2558	1/8 (3,18)	.750 (19,05)	1/16 (1,59)	.500 (12,70)	.375 (9,53)

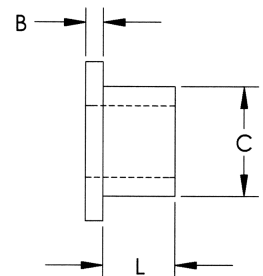
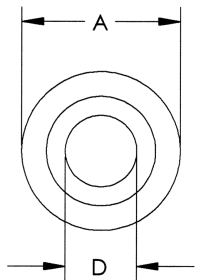

# WASHERS, SHOULDER WASHERS & SCREW INSULATORS

## SECTION IV

### NYLON SHOULDER WASHERS

Nylon Shoulder Washers are suitable for a large variety of insulation and mechanical applications.

- ▶ THEY SEAL
- ▶ REDUCE VIBRATION
- ▶ ACT AS SPACERS AND GUIDES
- ▶ STRONG AND CORROSION RESISTANT

**New Sizes**

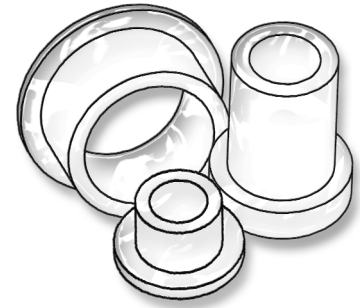

ITEM NUMBER	DESCRIPTION	L	A	B	C	D
12SWS2559	SWS 2559	.020 (0,51)	.750 (19,05)	.074 (1,88)	.495 (12,57)	.385 (9,78)
12SWS2560	SWS 2560	3/64 (1,19)	.750 (19,05)	1/32 (0,79)	.371 (9,42)	.253 (6,43)
12SWS2561	SWS 2561	27/64 (10,72)	.750 (19,05)	11/64 (4,37)	.434 (11,02)	.312 (7,93)
12SWS2562	SWS 2562	1/4 (3,38)	.755 (19,17)	5/64 (1,98)	.505 (12,83)	.378 (9,60)
12SWS2563	SWS 2563	3/32 (1,19)	.750 (19,05)	1/8 (3,18)	.375 (9,53)	.265 (6,73)
12SWS2564	SWS 2564	1/4 (6,35)	.750 (19,05)	1/16 (1,59)	.250 (6,35)	.150 (3,81)
12SWS2565	SWS 2565	.250 (6,35)	.750 (19,05)	.190 (4,83)	.500 (12,70)	.310 (7,87)
12SWS2566	SWS 2566	15/32 (11,90)	.740 (18,80)	5/32 (3,97)	.375 (9,53)	.250 (6,35)
12SWS2567	SWS 2567	.174 (4,42)	.750 (19,05)	.066 (1,68)	.625 (15,88)	.470 (11,94)
12SWS2568	SWS 2568	3/64 (1,19)	.750 (19,05)	1/32 (0,79)	.341 (8,66)	.253 (6,43)
12SWS2569	SWS 2569	.420 (10,67)	.550 (13,97)	.172 (4,37)	.436 (11,07)	.307 (7,80)
12SWS2570	SWS 2570	11/16 (17,46)	.740 (18,80)	9/64 (3,58)	.385 (9,78)	.260 (6,60)
12SWS2571	SWS 2571	.320 (8,13)	.750 (19,05)	.030 (0,76)	.580 (14,73)	.517 (13,13)
12SWS2572	SWS 2572	1/2 (12,70)	.750 (19,05)	1/16 (1,59)	.375 (9,53)	.125 (3,18)
12SWS2573	SWS 2573	.125 (3,18)	.750 (19,05)	.093 (2,36)	.375 (9,53)	.172 (4,37)
12SWS2574	SWS 2574	.360 (9,14)	.750 (19,05)	.062 (1,57)	.506 (12,85)	.380 (9,65)
12SWS2575	SWS 2575	51/64 (20,24)	.750 (19,06)	3/32 (2,38)	.315 (8,01)	.190 (4,83)
12SWS2576	SWS 2576	1/32 (0,76)	.750 (19,05)	1/32 (0,79)	.500 (12,70)	.219 (5,56)
12SWS2577	SWS 2577	.250 (6,35)	.750 (19,05)	.065 (1,65)	.320 (8,13)	.170 (4,32)
12SWS2578	SWS 2578	3/16 (4,76)	.750 (19,06)	1/16 (1,59)	.625 (15,88)	.510 (12,95)
12SWS2579	SWS 2579	.180 (4,57)	.750 (19,05)	.240 (6,10)	.500 (12,70)	.370 (9,40)
12SWS2580	SWS 2580	5/16 (7,94)	.745 (18,92)	1/32 (0,79)	.560 (14,22)	.500 (12,70)
12SWS2581	SWS 2581	1/4 (6,35)	.750 (19,05)	5/64 (1,98)	.505 (12,83)	.315 (8,00)
12SWS2584	SWS 2584	.050 (1,27)	.735 (18,67)	.050 (1,27)	.710 (18,03)	.640 (16,26)
12SWS2585	SWS 2585	1/4 (6,35)	.740 (18,80)	1/2 (12,70)	.605 (15,37)	.380 (9,65)
12SWS2586	SWS 2586	1/4 (6,35)	.750 (19,05)	1/8 (3,18)	.500 (12,70)	.281 (7,14)
12SWS2587	SWS 2587	7/16 (11,11)	3/4 (19,05)	1/16 (1,59)	5/8 (15,88)	1/2 (12,70)
12SWS2590	SWS 2590	.018 (0,46)	.745 (18,92)	.085 (2,16)	.305 (7,75)	.200 (5,08)
12SWS3001	SWS 3001	1/8 (3,18)	.693 (17,60)	1/16 (1,59)	.437 (11,10)	.328 (8,33)
12SWS3002	SWS 3002	3/64 (1,19)	.750 (19,05)	3/64 (1,19)	.375 (9,53)	.323 (8,20)
12SWS3003	SWS 3003	7/32 (5,55)	.750 (19,05)	3/32 (2,38)	.380 (9,65)	.266 (6,76)
12SWS3004	SWS 3004	1/16 (1,59)	.750 (19,05)	3/32 (2,38)	.359 (9,12)	.152 (3,86)
12SWS3005	SWS 3005	5/32 (3,97)	.750 (19,05)	1/32 (0,79)	.498 (12,64)	.378 (9,60)
12SWS3006	SWS 3006	1/32 (0,79)	.750 (19,05)	1/8 (3,18)	.500 (12,70)	.375 (9,53)
12SWS3007	SWS 3007	1/16 (1,59)	.750 (19,05)	1/8 (3,18)	.500 (12,70)	.375 (9,53)
12SWS3008	SWS 3008	1/16 (1,59)	.745 (18,92)	1/32 (0,79)	.370 (9,40)	.320 (8,13)
12SWS3009	SWS 3009	3/64 (1,19)	.760 (19,30)	5/64 (1,98)	.410 (10,41)	.258 (6,55)
12SWS3010	SWS 3010	.027 (0,68)	.750 (19,05)	.031 (0,79)	.310 (7,87)	.257 (6,53)
12SWS3011	SWS 3011	.196 (4,98)	.763 (19,38)	.026 (0,66)	.562 (14,27)	.394 (10,01)
12SWS3012	SWS 3012	.395 (10,03)	.740 (18,80)	.065 (1,65)	.430 (10,92)	.322 (8,18)
12SWS3015	SWS 3015	1.005 (25,53)	.752 (19,10)	.060 (1,52)	.505 (12,83)	.320 (8,13)
12SWS3016	SWS 3016	.050 (1,27)	.745 (18,82)	1/16 (1,59)	.556 (14,12)	.515 (13,08)
12SWS3017	SWS 3017	5/32 (3,97)	.755 (19,18)	1/2 (12,70)	.510 (12,95)	.385 (9,78)
12SWS3020	SWS 3020	.305 (7,75)	.740 (18,80)	.130 (3,30)	.495 (12,57)	.219 (5,56)
12SWS3021	SWS 3021	.440 (11,18)	.745 (18,92)	1/16 (1,59)	.495 (12,57)	.390 (9,91)

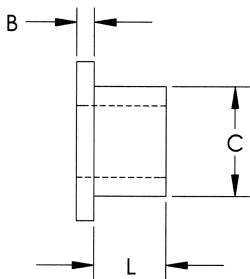
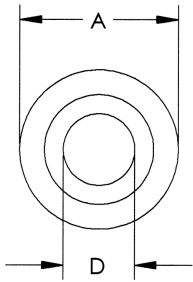

## NYLON SHOULDER WASHERS

Nylon Shoulder Washers are suitable for a large variety of insulation and mechanical applications.

- ▶ THEY SEAL
- ▶ REDUCE VIBRATION
- ▶ ACT AS SPACERS AND GUIDES
- ▶ STRONG AND CORROSION RESISTANT

New Sizes

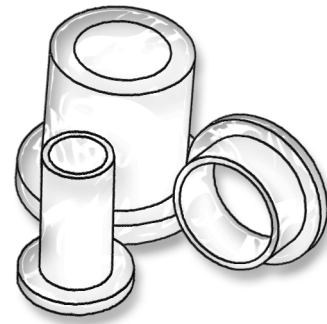

ITEM NUMBER	DESCRIPTION	L	A	B	C	D
12SWS3022	SWS 3022	.188 (4,78)	.750 (19,05)	.092 (2,34)	.627 (15,93)	.506 (12,85)
12SWS3023	SWS 3023	.216 (5,49)	.765 (19,43)	.126 (3,20)	.481 (12,22)	.250 (6,35)
12SWS3029	SWS 3029	.058 (1,47)	.788 (20,02)	.058 (1,47)	.710 (18,03)	.639 (16,23)
12SWS3030	SWS 3030	.252 (6,40)	.780 (19,81)	.079 (2,01)	.392 (9,96)	.250 (6,35)
12SWS3031	SWS 3031	.110 (2,79)	.810 (20,57)	.130 (3,30)	.498 (12,65)	.388 (9,86)
12SWS3032	SWS 3032	.108 (2,74)	.805 (20,45)	.132 (3,35)	.502 (12,75)	.324 (8,23)
12SWS3100	SWS 3100	.325 (8,26)	.825 (20,96)	.060 (1,52)	.435 (11,05)	.310 (7,87)
12SWS3101	SWS 3101	1/32 (0,79)	.750 (19,05)	1/16 (1,59)	.375 (9,53)	.260 (6,60)
12SWS3102	SWS 3102	1/2 (12,70)	.825 (20,96)	1/16 (1,59)	.620 (15,75)	.520 (13,21)
12SWS3103	SWS 3103	1/2 (12,70)	.872 (22,14)	1/8 (3,18)	.617 (15,67)	.335 (8,51)
12SWS3104	SWS 3104	.125 (3,18)	.750 (19,05)	.075 (1,91)	.437 (11,10)	.265 (6,73)
12SWS3105	SWS 3105	.190 (4,83)	.825 (20,96)	.060 (1,52)	.435 (11,05)	.310 (7,87)
12SWS3106	SWS 3106	.204 (5,18)	.875 (22,23)	.062 (1,57)	.626 (15,90)	.379 (9,63)
12SWS3149	SWS 3149	.455 (11,56)	.865 (21,97)	.045 (1,14)	.600 (15,24)	.510 (12,95)
12SWS3150	SWS 3150	1 (25,40)	.875 (22,23)	1/16 (1,59)	.500 (12,70)	.375 (9,53)
12SWS3151	SWS 3151	3/8 (9,53)	7/8 (22,22)	1/8 (3,17)	.633 (16,08)	.510 (12,95)
12SWS3155	SWS 3155	3/8 (9,53)	.875 (22,23)	1/8 (3,18)	.630 (16,00)	.440 (11,18)
12SWS3156	SWS 3156	.689 (17,50)	.874 (22,20)	.063 (1,60)	.634 (16,10)	.507 (12,88)
12SWS3160	SWS 3160	1/2 (12,70)	.875 (22,23)	1/16 (1,59)	.750 (19,05)	.635 (16,13)
12SWS3161	SWS 3161	.335 (8,51)	.875 (22,23)	.040 (1,02)	.688 (17,48)	.569 (14,45)
12SWS3165	SWS 3165	3/8 (9,53)	.875 (22,23)	1/8 (3,18)	.620 (15,75)	.250 (6,35)
12SWS3200	SWS 3200	3/16 (4,76)	.995 (25,27)	1/8 (3,18)	.792 (20,12)	.695 (17,65)
12SWS3205	SWS 3205	5/8 (15,88)	.995 (25,27)	1/8 (3,18)	.787 (19,99)	.695 (17,65)
12SWS3206	SWW 3206	.200 (5,08)	1.000 (25,40)	.050 (1,27)	.780 (19,81)	.640 (16,26)
12SWS3210	SWS 3210	1 (25,40)	.995 (25,27)	1/8 (3,18)	.787 (19,99)	.695 (17,65)
12SWS3500	SWS 3500	3/16 (4,76)	.750 (19,05)	1/16 (1,59)	.498 (12,64)	.378 (9,60)
12SWS3501	SWS 3501	7/64 (2,77)	.750 (19,05)	3/32 (2,38)	.577 (14,66)	.390 (9,91)
12SWS3502	SWS 3502	27/64 (10,72)	.790 (20,07)	3/64 (1,19)	.625 (15,88)	.550 (13,97)
12SWS3503	SWS 3503	13/16 (20,64)	.625 (15,88)	1/8 (3,18)	.375 (9,53)	.255 (6,47)
12SWS3504	SWS 3504	13/16 (20,64)	.625 (15,88)	1/8 (3,18)	.375 (9,53)	.260 (6,60)
12SWS3505	SWS 3505	.100 (2,54)	.800 (20,32)	.055 (1,40)	.655 (16,64)	.563 (14,30)
12SWS3506	SWS 3506	.263 (6,68)	.760 (19,30)	.127 (3,23)	.370 (9,40)	.267 (6,78)
12SWS3507	SWS 3507	.250 (6,35)	.830 (21,08)	.100 (2,54)	.452 (11,18)	.253 (6,43)
12SWS3510	SWS 3510	13/32 (10,32)	.825 (20,96)	3/32 (2,38)	.445 (11,30)	.306 (7,77)
12SWS3511	SWS 3511	13/64 (5,16)	.880 (22,35)	3/64 (1,19)	.750 (19,05)	.617 (15,67)
12SWS3512	SWS 3512	.935 (23,75)	.872 (22,15)	.110 (2,79)	.497 (12,62)	.385 (9,78)
12SWS3513	SWS 3513	.250 (6,35)	.875 (22,22)	.125 (3,17)	.617 (15,67)	.335 (8,51)
12SWS3514	SWS 3514	3/8 (9,53)	7/8 (22,23)	1/16 (1,57)	31/64 (12,29)	.386 (9,80)
12SWS3515	SWS 3515	3/8 (9,53)	7/8 (22,23)	1/16 (1,57)	17/32 (13,49)	.438 (11,13)
12SWS3520	SWS 3520	17/32 (13,49)	.945 (24,03)	5/64 (1,98)	.470 (11,93)	.406 (10,31)
12SWS3521	SWS 3521	.060 (1,52)	.940 (23,88)	.090 (2,29)	.560 (14,22)	.257 (6,53)
12SWS3562	SWS 3562	1/4 (6,35)	.980 (24,89)	1/8 (3,18)	.556 (14,12)	.380 (9,65)
12SWS3563	SWS 3563	.080 (2,03)	1.000 (25,40)	.125 (3,18)	.306 (7,77)	.205 (5,21)
12SWS3564	SWS 3564	.250 (6,35)	.980 (24,89)	.125 (3,18)	.546 (13,87)	.406 (10,31)
12SWS3580	SWS 3580	9/16 (14,29)	1.25 (31,75)	3/64 (1,19)	1.00 (25,40)	.559 (14,20)

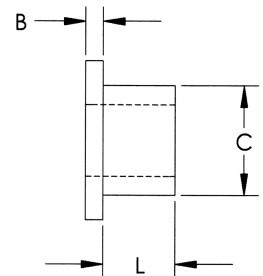
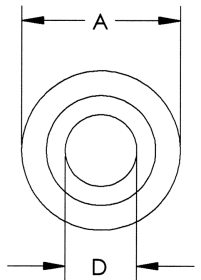



# WASHERS, SHOULDER WASHERS & SCREW INSULATORS

SECTION  
IV

## NYLON SHOULDER WASHERS

New Sizes

ITEM NUMBER	DESCRIPTION	L	A	B	C	D
12SWS3598	SWS 3598	.200 (5,08)	1.000 (25,40)	.050 (1,27)	.750 (19,05)	.630 (16,00)
12SWS3599	SWS 3599	5/8 (15,88)	1" (25,40)	1/8 (3,18)	.666 (16,92)	.520 (13,21)
12SWS3600	SWS 3600	.660 (16,76)	1.010 (25,65)	.160 (4,06)	.600 (15,24)	.260 (6,60)
12SWS3601	SWS 3601	3/16 (4,76)	1.000 (25,40)	1/4 (6,35)	.435 (11,05)	.325 (8,26)
12SWS3602	SWS 3602	1/32 (0,79)	1.000 (25,40)	3/32 (2,38)	.616 (15,65)	.515 (13,08)
12SWS3603	SWS 3603	.050 (1,27)	1.005 (25,53)	.070 (1,78)	.500 (12,70)	.453 (11,51)
12SWS3604	SWS 3604	.243 (6,17)	1.006 (25,55)	.078 (1,98)	.504 (12,80)	.376 (9,55)
12SWS3605	SWS 3605	5/16 (7,94)	1.005 (25,53)	1/16 (1,59)	.500 (12,70)	.375 (9,53)
12SWS3606	SWS 3606	.33 (8,38)	1.00 (25,40)	.04 (1,02)	.625 (15,87)	.515 (13,08)
12SWS3607	SWS 3607	.521 (13,23)	1.068 (27,13)	.062 (1,57)	.896 (22,76)	.630 (16,00)
12SWS3608	SWS 3608	.500 (12,70)	1.000 (25,40)	.125 (3,18)	.687 (17,45)	.510 (12,95)
12SWS3609	SWS 3609	.120 (3,05)	1.000 (25,40)	.130 (3,30)	.745 (18,92)	.645 (16,38)
12SWS3610	SWS 3610	9/16 (14,29)	1.000 (25,40)	1/16 (1,59)	.500 (12,70)	.382 (9,70)
12SWS3612	SWS 3612	.085 (2,16)	1.000 (25,40)	.075 (1,91)	.562 (14,27)	.190 (4,83)
12SWS3615	SWS 3615	3/4 (19,05)	1.000 (25,40)	1/8 (3,18)	.500 (12,70)	3/8 (9,53)
12SWS3650	SWS 3650	7/64 (2,77)	1.000 (25,40)	5/64 (1,98)	.770 (19,56)	.508 (12,90)
12SWS3680	SWS 3680	1/16 (1,59)	1.000 (25,40)	1/16 (1,59)	.298 (7,57)	.203 (5,16)
12SWS3685	SWS 3685	1/16 (1,59)	1.064 (27,02)	1/16 (1,59)	.787 (19,99)	.612 (15,54)
12SWS3686	SWS 3686	9/32 (7,14)	1.105 (28,07)	.092 (2,34)	.718 (18,24)	.515 (13,08)
12SWS3687	SWS 3687	.118 (3,00)	1.102 (27,99)	.039 (0,99)	.906 (23,01)	.827 (21,01)
12SWS3688	SWS 3688	.313 (7,95)	1.130 (28,70)	.062 (1,57)	.880 (22,35)	.750 (19,05)
12SWS3689	SWS 3689	.313 (7,95)	1.130 (28,70)	.062 (1,57)	.880 (22,35)	.758 (19,25)
12SWS3690	SWS 3690	7/16 (11,11)	1.125 (28,58)	3/32 (2,38)	.700 (17,78)	.510 (12,95)
12SWS3691	SWS 3691	.060 (1,52)	1.160 (29,46)	.128 (3,25)	.495 (12,57)	.377 (9,58)
12SWS3693	SWS 3693	.422 (10,72)	1.250 (31,75)	.156 (3,96)	1.002 (25,45)	.818 (20,78)
12SWS3694	SWS 3694	.250 (6,35)	1.125 (28,58)	.187 (4,75)	.718 (18,24)	.515 (13,08)
12SWS3695	SWS 3695	.125 (3,18)	1.250 (31,75)	.045 (1,14)	.480 (12,19)	.380 (9,65)
12SWS3696	SWS 3696	.100 (2,54)	1.250 (31,75)	.150 (3,81)	1.000 (25,40)	.340 (8,64)
12SWS3697	SWS 3697	.100 (2,54)	1.250 (31,75)	.212 (5,38)	1.000 (25,40)	.340 (8,64)
12SWS4001	SWS 4001	3/32 (2,38)	1.125 (28,58)	1/16 (1,59)	.740 (18,80)	.515 (13,08)
12SWS4002	SWS 4002	3/32 (2,38)	1.230 (31,24)	1/16 (1,59)	.980 (24,89)	.510 (12,95)
12SWS4003	SWS 4003	9/32 (7,14)	1.105 (28,07)	1/8 (3,18)	.752 (19,10)	.515 (13,08)
12SWS4004	SWS 4004	1/2 (12,70)	1.245 (31,69)	1/8 (3,18)	.875 (22,23)	.627 (15,92)
12SWS4005	SWS 4005	13/32 (10,32)	1.252 (31,80)	1/16 (1,59)	.600 (15,24)	.538 (13,66)
12SWS4006	SWS 4006	13/32 (10,32)	1.251 (31,77)	1/16 (1,59)	.528 (13,41)	.471 (11,96)
12SWS4007	SWS 4007	13/64 (5,16)	1.739 (44,17)	13/64 (5,16)	1.095 (27,81)	.435 (11,04)
12SWS4008	SWS 4008	11/32 (8,71)	1.250 (31,75)	5/32 (3,97)	.995 (25,27)	.885 (22,48)
12SWS4009	SWS 4009	3/4 (19,05)	1 1/8 (28,57)	1/16 (1,59)	7/16 (11,11)	5/16 (7,94)
12SWS4010	SWS 4010	3/32 (2,38)	1.250 (31,75)	1/16 (1,59)	.930 (23,62)	.562 (14,27)
12SWS4011	SWS 4011	.094 (2,39)	1.250 (31,75)	.062 (1,57)	.989 (25,12)	.562 (14,27)
12SWS4012	SWS 4012	.060 (1,52)	1.650 (41,91)	.060 (1,52)	1.380 (35,05)	1.125 (28,58)
12SWS4013	SWS 4013	5/8 (15,88)	1-3/4 (44,45)	1/8 (3,18)	1-3/8 (34,93)	1.015 (25,78)
12SWS4014	SWS 4014	.238 (6,04)	1.501 (38,12)	.133 (3,38)	1.248 (31,70)	.942 (23,92)
12SWS4016	SWS 4016	.100 (2,54)	1.250 (31,75)	.250 (6,35)	.419 (10,64)	.254 (6,45)
12SWS4017	SWS 4017	.170 (4,32)	1.570 (39,88)	.175 (4,45)	1.055 (26,80)	.887 (22,53)
12SWS4018	SWS 4018	.250 (6,35)	1.500 (38,10)	.120 (3,05)	.615 (15,62)	.265 (6,73)
12SWS4019	SWS 4019	.309 (7,85)	1.365 (34,67)	.128 (3,25)	1.120 (28,45)	.870 (22,10)
12SWS5000	SWS 5000	5/8 (15,88)	1.952 (49,58)	.125 (3,18)	31/64 (12,29)	.380 (9,65)
12SWS5001	SWS 5001	1/2 (12,70)	2.065 (52,45)	1/8 (3,18)	1.050 (26,67)	.806 (20,42)
12SWS5002	SWS 5002	.500 (12,70)	2.065 (52,45)	.125 (3,18)	1.050 (26,67)	.783 (19,89)
12SWS5003	SWS 5003	.305 (7,75)	1.989 (50,52)	.129 (3,28)	1.743 (44,27)	1.326 (33,68)
12SWS5009	SWS 5009	45/64 (17,85)	2.111 (53,62)	1/8 (3,18)	.603 (15,31)	.270 (6,85)
12SWS5050	SWS 5050	1/2 (12,70)	1.525 (38,74)	1/16 (1,57)	3/4 (19,05)	.650 (16,51)

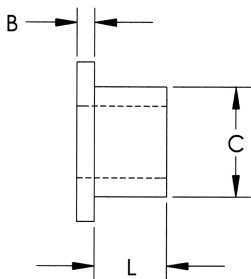
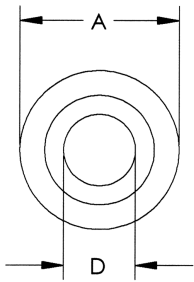

# WASHERS, SHOULDER WASHERS & SCREW INSULATORS

## NYLON SCREW INSULATORS

**METRIC Sizes**  
Also Available  
Page 242

SECTION  
**IV**

Screw Insulators may also be used as light load bearings in many applications.

ITEM NUMBER	DESCRIPTION	L	A	B	C	D
10SC002012	SC 2	1/8 (3,18)	.181 (4,60)	3/64 (1,19)	.120 (3,05)	.090 (2,29)
10SC002018	SC 2	3/16 (4,76)	.181 (4,60)	3/64 (1,19)	.120 (3,05)	.090 (2,29)
10SC002025	SC 2	1/4 (6,35)	.181 (4,60)	3/64 (1,19)	.120 (3,05)	.090 (2,29)
10SC002037	SC 2	3/8 (9,53)	.181 (4,60)	3/64 (1,19)	.120 (3,05)	.090 (2,29)
10SC004003	SC 4	1/32 (0,79)	.235 (5,97)	3/64 (1,19)	.145 (3,68)	.115 (2,92)
10SC004004	SC 4	3/64 (1,19)	.235 (5,97)	3/64 (1,19)	.145 (3,68)	.115 (2,92)
10SC004006	SC 4	1/16 (1,59)	.235 (5,97)	3/64 (1,19)	.145 (3,68)	.115 (2,92)
10SC004009	SC 4	3/32 (2,38)	.235 (5,97)	3/64 (1,19)	.145 (3,68)	.115 (2,92)
10SC004012	SC 4	1/8 (3,18)	.235 (5,97)	3/64 (1,19)	.145 (3,68)	.115 (2,92)
10SC004015	SC 4	5/32 (3,97)	.235 (5,97)	3/64 (1,19)	.145 (3,68)	.115 (2,92)
10SC004018	SC 4	3/16 (4,76)	.235 (5,97)	3/64 (1,19)	.145 (3,68)	.115 (2,92)
10SC004025	SC 4	1/4 (6,35)	.235 (5,97)	3/64 (1,19)	.145 (3,68)	.115 (2,92)
10SC004037	SC 4	3/8 (9,53)	.235 (5,97)	3/64 (1,19)	.145 (3,68)	.115 (2,92)
10SC004050	SC 4	1/2 (12,70)	.235 (5,97)	3/64 (1,19)	.145 (3,68)	.115 (2,92)
10SC006004	SC 6	3/64 (1,19)	.290 (7,37)	3/64 (1,19)	.170 (4,32)	.140 (3,56)
10SC006006	SC 6	1/16 (1,59)	.290 (7,37)	3/64 (1,19)	.170 (4,32)	.140 (3,56)
10SC006009	SC 6	3/32 (2,38)	.290 (7,37)	3/64 (1,19)	.170 (4,32)	.140 (3,56)
10SC006012	SC 6	1/8 (3,18)	.290 (7,37)	3/64 (1,19)	.170 (4,32)	.140 (3,56)
10SC006015	SC 6	5/32 (3,97)	.290 (7,37)	3/64 (1,19)	.170 (4,32)	.140 (3,56)
10SC006018	SC 6	3/16 (4,76)	.290 (7,37)	3/64 (1,19)	.170 (4,32)	.140 (3,56)
10SC006025	SC 6	1/4 (6,35)	.290 (7,37)	3/64 (1,19)	.170 (4,32)	.140 (3,56)
10SC006037	SC 6	3/8 (9,53)	.290 (7,37)	3/64 (1,19)	.170 (4,32)	.140 (3,56)
10SC006050	SC 6	1/2 (12,70)	.290 (7,37)	3/64 (1,19)	.170 (4,32)	.140 (3,56)
10SC008012	SC 8	1/8 (3,18)	.344 (8,74)	1/16 (1,59)	.205 (5,21)	.173 (4,39)
10SC008014	SC 8	9/64 (3,58)	.344 (8,74)	1/16 (1,59)	.205 (5,21)	.173 (4,39)
10SC008025	SC 8	1/4 (6,35)	.344 (8,74)	1/16 (1,59)	.205 (5,21)	.173 (4,39)
10SC008037	SC 8	3/8 (9,53)	.344 (8,74)	1/16 (1,59)	.205 (5,21)	.173 (4,39)
10SC008050	SC 8	1/2 (12,70)	.344 (8,74)	1/16 (1,59)	.205 (5,21)	.173 (4,39)
10SC008062	SC 8	5/8 (15,88)	.344 (8,74)	1/16 (1,59)	.205 (5,21)	.173 (4,39)
10SC008075	SC 8	3/4 (19,05)	.344 (8,74)	1/16 (1,59)	.205 (5,21)	.173 (4,39)
10SC010006	SC 10	1/16 (1,59)	.399 (10,13)	1/16 (1,59)	.260 (6,60)	.200 (5,08)
10SC010014	SC 10	9/64 (3,58)	.399 (10,13)	1/16 (1,59)	.260 (6,60)	.200 (5,08)
10SC010018	SC 10	3/16 (4,76)	.399 (10,13)	1/16 (1,59)	.260 (6,60)	.200 (5,08)
10SC010025	SC 10	1/4 (6,35)	.399 (10,13)	1/16 (1,59)	.260 (6,60)	.200 (5,08)
10SC010037	SC 10	3/8 (9,53)	.399 (10,13)	1/16 (1,59)	.260 (6,60)	.200 (5,08)
10SC010050	SC 10	1/2 (12,70)	.399 (10,13)	1/16 (1,59)	.260 (6,60)	.200 (5,08)
10SC010056	SC 10	9/16 (14,29)	.399 (10,13)	1/16 (1,59)	.260 (6,60)	.200 (5,08)
10SC010062	SC 10	5/8 (15,88)	.399 (10,13)	1/16 (1,59)	.260 (6,60)	.200 (5,08)
10SC010075	SC 10	3/4 (19,05)	.399 (10,13)	1/16 (1,59)	.260 (6,60)	.200 (5,08)
10SC250012	SC 250	1/8 (3,18)	.513 (13,03)	1/16 (1,59)	.312 (7,92)	.260 (6,60)
10SC250014	SC 250	9/64 (3,58)	.513 (13,03)	1/16 (1,59)	.312 (7,92)	.260 (6,60)
10SC250018	SC 250	3/16 (4,76)	.513 (13,03)	1/16 (1,59)	.312 (7,92)	.260 (6,60)
10SC250025	SC 250	1/4 (6,35)	.513 (13,03)	1/16 (1,59)	.312 (7,92)	.260 (6,60)
10SC250032	SC 250	1/4 (6,35)	.513 (13,03)	1/32 (0,79)	.312 (7,92)	.260 (6,60)
10SC250037	SC 250	3/8 (9,53)	.513 (13,03)	1/16 (1,59)	.312 (7,92)	.260 (6,60)
10SC250050	SC 250	1/2 (12,70)	.513 (13,03)	1/16 (1,59)	.312 (7,92)	.260 (6,60)
10SC250062	SC 250	5/8 (15,88)	.513 (13,03)	1/16 (1,59)	.312 (7,92)	.260 (6,60)
10SC250075	SC 250	3/4 (19,05)	.513 (13,03)	1/16 (1,59)	.312 (7,92)	.260 (6,60)
10SC312012	SC 312	1/8 (3,18)	.620 (15,75)	1/16 (1,59)	.360 (9,14)	.320 (8,13)
10SC312025	SC 312	1/4 (6,35)	.620 (15,75)	1/16 (1,59)	.360 (9,14)	.320 (8,13)
10SC312037	SC 312	3/8 (9,53)	.620 (15,75)	1/16 (1,59)	.360 (9,14)	.320 (8,13)
10SC312050	SC 312	1/2 (12,70)	.620 (15,75)	1/16 (1,59)	.360 (9,14)	.320 (8,13)
10SC312062	SC 312	5/8 (15,88)	.620 (15,75)	1/16 (1,59)	.360 (9,14)	.320 (8,13)

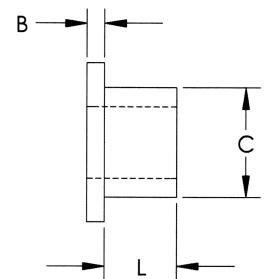
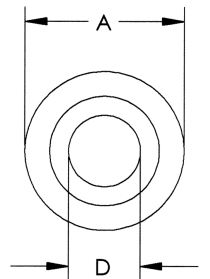
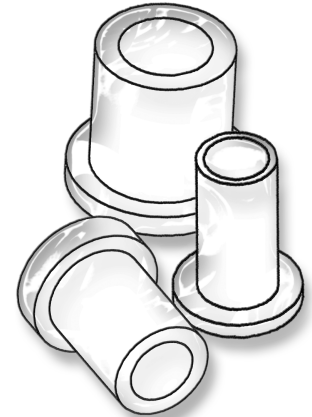

Specify screw size and length when ordering. Specials can be made to order for a small tooling charge.



# WASHERS, SHOULDER WASHERS & SCREW INSULATORS

## SECTION IV

Nylon Cup Washers are designed to :

- Protect the head of a metal screw from electrical contact.  
Accommodate the most common screw head-styles including:
- Cheese, Pan and Fillister, in sizes from #4 TO 1/4".

Cup Washers are molded from tough, electrically insulating Nylon 6/6.

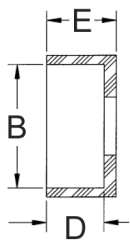
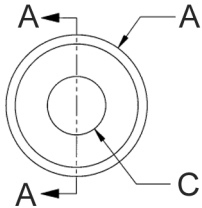
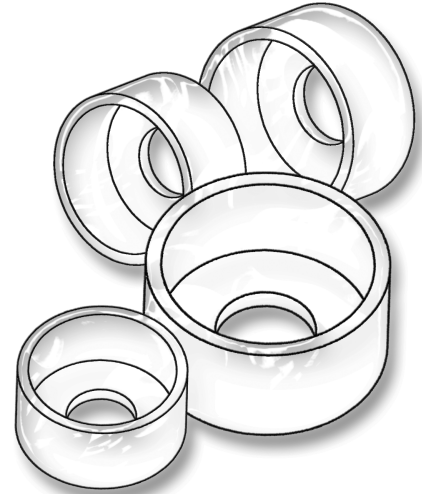

## NYLON CUP WASHERS

ITEM NUMBER	A	B	C	D	E
16CW004040	.305 (7,76)	.245 (6,22)	.115 (2,92)	.117 (2,97)	.157 (3,99)
16CW006040	.360 (9,14)	.300 (7,62)	.140 (3,56)	.142 (3,61)	.182 (4,62)
16CW008040	.414 (10,52)	.354 (8,99)	.171 (4,34)	.166 (4,22)	.206 (5,23)
16CW008042	.497 (12,62)	.389 (9,88)	.187 (4,75)	.093 (2,36)	.139 (3,53)
16CW008041	.414 (10,52)	.354 (8,99)	.171 (4,34)	.130 (3,30)	.170 (4,32)
16CW010030	.568 (14,43)	.375 (9,53)	.201 (5,11)	.127 (3,23)	.157 (3,99)
16CW010040	.470 (11,94)	.410 (10,41)	.194 (4,93)	.190 (4,83)	.230 (5,85)
16CW250040	.595 (15,11)	.535 (13,59)	.257 (6,53)	.247 (6,27)	.287 (7,29)
16CW312375	.875 (22,23)	.625 (15,88)	.344 (8,74)	.250 (6,35)	.375 (9,53)
16CW312500	.875 (22,23)	.625 (15,88)	.344 (8,74)	.375 (9,53)	.500 (12,70)

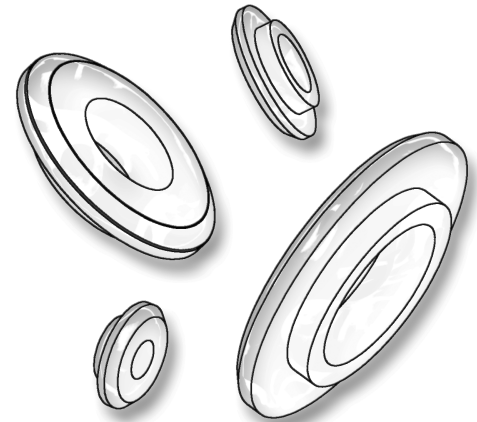

## NYLON STANDARD SHOULDER WASHERS

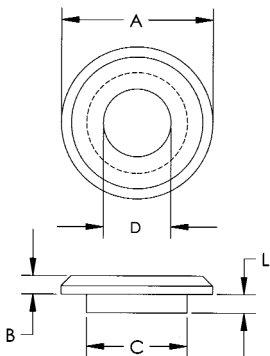

ITEM NUMBER	DESCRIPTION	L	A	B	C	D
24SW0002	SW 2	.040 (1,02)	.250 (6,35)	.040 (1,02)	.156 (3,96)	.093 (2,36)
24SW0004	SW 4	.040 (1,02)	.281 (7,14)	.040 (1,02)	.187 (4,75)	.122 (3,09)
24SW0006	SW 6	.040 (1,02)	.328 (8,33)	.040 (1,02)	.218 (5,54)	.146 (3,71)
24SW0008	SW 8	.050 (1,27)	.375 (9,53)	.050 (1,27)	.250 (6,35)	.174 (4,42)
24SW0010	SW 10	.050 (1,27)	.437 (11,10)	.050 (1,27)	.281 (7,14)	.201 (5,11)
24SW0250	SW1/4	.060 (1,52)	.562 (14,27)	.060 (1,52)	.375 (9,53)	.260 (6,60)
24SW0375	SW3/8	.060 (1,52)	.750 (19,05)	.060 (1,52)	.500 (12,70)	.385 (9,78)