

# METRIC SCREWS, BOLTS AND THREADED ROD

SECTION  
**XIII**

ALL DIMENSIONS ARE IN MILLIMETERS

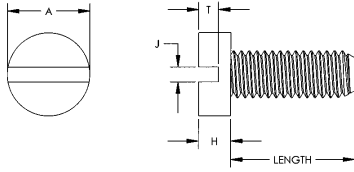

Nominal Screw Length	Tolerance On Length mm
to 3 mm incl.	0.2
over 3 to 10 mm	0.3
over 10 to 16 mm	0.4
over 16 to 50 mm	0.5
over 50 mm	1.0

All tolerances are plus and minus.

THREAD SIZE	A	H	J	T
M2 X 0.4	3.80	1.30	0.70	0.90
M2.5 X 0.45	4.50	1.60	0.80	1.00
M3 X 0.5	5.50	2.00	1.00	1.30
M3.5 X 0.6	6.00	2.40	1.10	1.40
M4 X 0.7	7.00	2.60	1.20	1.60
M5 X .08	8.50	3.30	1.50	2.00
M6 X 1.0	10.00	3.90	1.90	2.30
M8 X 1.25	13.00	5.00	2.30	2.80
M10 X 1.5	15.63	6.00	2.80	3.20

**CHEESE  
SLOTTED**

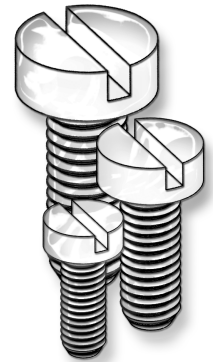

ITEM NUMBER	DESCRIPTION	ITEM NUMBER	DESCRIPTION
50M020040D004	M2 X .4 X 4MM Cheese Slot	50M040070D020	M4 X .7 X 20MM Cheese Slot
50M020040D005	M2 X .4 X 5MM Cheese Slot	50M040070D025	M4 X .7 X 25MM Cheese Slot
50M020040D006	M2 X .4 X 6MM Cheese Slot	50M040070D030	M4 X .7 X 30MM Cheese Slot
50M020040D008	M2 X .4 X 8MM Cheese Slot	50M040070D035	M4 X .7 X 35MM Cheese Slot
50M020040D010	M2 X .4 X 10MM Cheese Slot	50M040070D040	M4 X .7 X 40MM Cheese Slot
50M020040D012	M2 X .4 X 12MM Cheese Slot	50M050080D006	M5 X .8 X 6MM Cheese Slot
50M020040D016	M2 X .4 X 16MM Cheese Slot	50M050080D008	M5 X .8 X 8MM Cheese Slot
50M020040D020	M2 X .4 X 20MM Cheese Slot	50M050080D010	M5 X .8 X 10MM Cheese Slot
50M020040D025	M2 X .4 X 25MM Cheese Slot	50M050080D012	M5 X .8 X 12MM Cheese Slot
50M025045D004	M2.5 X .45 X 4MM Cheese Slot	50M050080D016	M5 X .8 X 16MM Cheese Slot
50M025045D005	M2.5 X .45 X 5MM Cheese Slot	50M050080D020	M5 X .8 X 20MM Cheese Slot
50M025045D006	M2.5 X .45 X 6MM Cheese Slot	50M050080D025	M5 X .8 X 25MM Cheese Slot
50M025045D008	M2.5 X .45 X 8MM Cheese Slot	50M050080D030	M5 X .8 X 30MM Cheese Slot
50M025045D010	M2.5 X .45 X 10MM Cheese Slot	50M050080D035	M5 X .8 X 35MM Cheese Slot
50M025045D012	M2.5 X .45 X 12MM Cheese Slot	50M050080D040	M5 X .8 X 40MM Cheese Slot
50M025045D016	M2.5 X .45 X 16MM Cheese Slot	50M060100D005	M6 X 1.0 X 5MM Cheese Slot
50M025045D020	M2.5 X .45 X 20MM Cheese Slot	50M060100D008	M6 X 1.0 X 8MM Cheese Slot
50M025045D025	M2.5 X .45 X 25MM Cheese Slot	50M060100D010	M6 X 1.0 X 10MM Cheese Slot
50M030050D004	M3 X .5 X 4MM Cheese Slot	50M060100D012	M6 X 1.0 X 12MM Cheese Slot
50M030050D005	M3 X .5 X 5MM Cheese Slot	50M060100D016	M6 X 1.0 X 16MM Cheese Slot
50M030050D006	M3 X .5 X 6MM Cheese Slot	50M060100D020	M6 X 1.0 X 20MM Cheese Slot
50M030050D008	M3 X .5 X 8MM Cheese Slot	50M060100D025	M6 X 1.0 X 25MM Cheese Slot
50M030050D010	M3 X .5 X 10MM Cheese Slot	50M060100D030	M6 X 1.0 X 30MM Cheese Slot
50M030050D012	M3 X .5 X 12MM Cheese Slot	50M060100D035	M6 X 1.0 X 35MM Cheese Slot
50M030050D014	M3 X .5 X 14MM Cheese Slot	50M060100D040	M6 X 1.0 X 40MM Cheese Slot
50M030050D016	M3 X .5 X 16MM Cheese Slot	50M060100D045	M6 X 1.0 X 45MM Cheese Slot
50M030050D020	M3 X .5 X 20MM Cheese Slot	50M060100D050	M6 X 1.0 X 50MM Cheese Slot
50M030050D025	M3 X .5 X 25MM Cheese Slot	50M060100D060	M6 X 1.0 X 60MM Cheese Slot
50M030050D030	M3 X .5 X 30MM Cheese Slot	50M060100D065	M6 X 1.0 X 65MM Cheese Slot
50M030050D035	M3 X .5 X 35MM Cheese Slot	50M060100D070	M6 X 1.0 X 70MM Cheese Slot
50M030050D042	M3 X .5 X 42MM Cheese Slot	50M060100D075	M6 X 1.0 X 75MM Cheese Slot
50M035060D005	M3.5 X .6 X 5MM Cheese Slot	50M080125D010	M8 X 1.25 X 10MM Cheese Slot
50M035060D006	M3.5 X .6 X 6MM Cheese Slot	50M080125D016	M8 X 1.25 X 16MM Cheese Slot
50M035060D008	M3.5 X .6 X 8MM Cheese Slot	50M080125D020	M8 X 1.25 X 20MM Cheese Slot
50M035060D010	M3.5 X .6 X 10MM Cheese Slot	50M080125D025	M8 X 1.25 X 25MM Cheese Slot
50M035060D012	M3.5 X .6 X 12MM Cheese Slot	50M080125D030	M8 X 1.25 X 30MM Cheese Slot
50M035060D016	M3.5 X .6 X 16MM Cheese Slot	50M080125D035	M8 X 1.25 X 35MM Cheese Slot
50M035060D020	M3.5 X .6 X 20MM Cheese Slot	50M080125D050	M8 X 1.25 X 50MM Cheese Slot
50M035060D025	M3.5 X .6 X 25MM Cheese Slot	50M080125D070	M8 X 1.25 X 70MM Cheese Slot
50M035060D035	M3.5 X .6 X 35MM Cheese Slot	50M100150D016	M10 X 1.50 X 16MM Cheese Slot
50M035060D042	M3.5 X .6 X 42MM Cheese Slot	50M100150D020	M10 X 1.50 X 20MM Cheese Slot
50M040070D004	M4 X .7 X 4MM Cheese Slot	50M100150D025	M10 X 1.50 X 25MM Cheese Slot
50M040070D006	M4 X .7 X 6MM Cheese Slot	50M100150D030	M10 X 1.50 X 30MM Cheese Slot
50M040070D008	M4 X .7 X 8MM Cheese Slot	50M100150D035	M10 X 1.50 X 35MM Cheese Slot
50M040070D010	M4 X .7 X 10MM Cheese Slot	50M100150D050	M10 X 1.50 X 50MM Cheese Slot
50M040070D012	M4 X .7 X 12MM Cheese Slot	50M100150D060	M10 X 1.50 X 60MM Cheese Slot
50M040070D016	M4 X .7 X 16MM Cheese Slot		



# METRIC SCREWS, BOLTS AND THREADED ROD

## SECTION XIII

THREAD SIZE	A	W	H	J	T
M2	.302 - .320	3.38 min.	1.3 - 1.6	.60	.46
M2.5	3.82 - 4.00	4.28 min.	1.8 - 2.1	.80	.99
M3	4.82 - 5.00	5.40 min.	2.0 - 2.3	.99	1.30
M3.5	5.32 - 5.50	5.96 min.	2.3 - 2.6	1.20	1.28
M4	6.78 - 7.00	7.59 min.	2.6 - 3.0	1.24	1.28
M5	7.78 - 8.00	8.71 min.	3.3 - 3.8	1.30	1.40
M6	9.78 - 10.00	10.95 min.	4.1 - 4.7	1.70	2.24
M8	12.73 - 13.00	14.26 min.	5.2 - 6.0	2.15	2.27
M10	15.73 - 16.00	17.62 min.	6.5 - 7.5	2.38	2.90

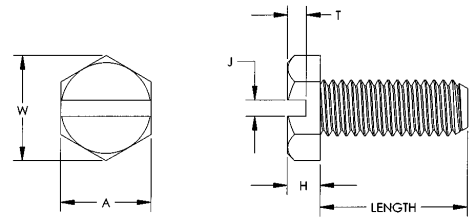

## HEX SLOTTED

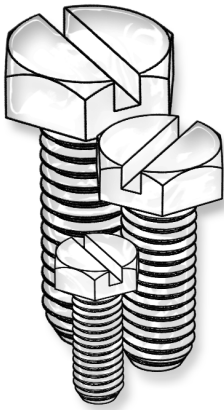

Nominal Screw Length	Tolerance On Length mm
to 3 mm incl.	0.2
over 3 to 10 mm	0.3
over 10 to 16 mm	0.4
over 16 to 50 mm	0.5
over 50 mm	1.0

All tolerances are plus and minus.

### ITEM NUMBER ----- DESCRIPTION -----

50M020040K004	M2	X .4 X	4MM	HEX SL
50M020040K005	M2	X .4 X	5MM	HEX SL
50M020040K006	M2	X .4 X	6MM	HEX SL
50M020040K008	M2	X .4 X	8MM	HEX SL
50M020040K010	M2	X .4 X	10MM	HEX SL
50M020040K012	M2	X .4 X	12MM	HEX SL
50M020040K016	M2	X .4 X	16MM	HEX SL
50M020040K020	M2	X .4 X	20MM	HEX SL
50M020040K025	M2	X .4 X	25MM	HEX SL
50M025045K004	M2.5	X .45 X	4MM	HEX SL
50M025045K005	M2.5	X .45 X	5MM	HEX SL
50M025045K006	M2.5	X .45 X	6MM	HEX SL
50M025045K008	M2.5	X .45 X	8MM	HEX SL
50M025045K010	M2.5	X .45 X	10MM	HEX SL
50M025045K012	M2.5	X .45 X	12MM	HEX SL
50M025045K016	M2.5	X .45 X	16MM	HEX SL
50M025045K020	M2.5	X .45 X	20MM	HEX SL
50M025045K025	M2.5	X .45 X	25MM	HEX SL
50M030050K004	M3	X .5 X	4MM	HEX SL
50M030050K005	M3	X .5 X	5MM	HEX SL
50M030050K006	M3	X .5 X	6MM	HEX SL
50M030050K008	M3	X .5 X	8MM	HEX SL
50M030050K010	M3	X .5 X	10MM	HEX SL
50M030050K012	M3	X .5 X	12MM	HEX SL
50M030050K016	M3	X .5 X	16MM	HEX SL
50M030050K020	M3	X .5 X	20MM	HEX SL
50M030050K025	M3	X .5 X	25MM	HEX SL
50M030050K030	M3	X .5 X	30MM	HEX SL
50M030050K035	M3	X .5 X	35MM	HEX SL
50M030050K042	M3	X .5 X	42MM	HEX SL
50M035060K005	M3.5	X .6 X	5MM	HEX SL
50M035060K006	M3.5	X .6 X	6MM	HEX SL
50M035060K007	M3.5	X .6 X	7MM	HEX SL
50M035060K008	M3.5	X .6 X	8MM	HEX SL
50M035060K010	M3.5	X .6 X	10MM	HEX SL
50M035060K012	M3.5	X .6 X	12MM	HEX SL
50M035060K016	M3.5	X .6 X	16MM	HEX SL
50M035060K020	M3.5	X .6 X	20MM	HEX SL
50M035060K025	M3.5	X .6 X	25MM	HEX SL
50M035060K035	M3.5	X .6 X	35MM	HEX SL
50M035060K042	M3.5	X .6 X	42MM	HEX SL
50M040070K006	M4	X .7 X	6MM	HEX SL
50M040070K008	M4	X .7 X	8MM	HEX SL
50M040070K010	M4	X .7 X	10MM	HEX SL
50M040070K012	M4	X .7 X	12MM	HEX SL
50M040070K016	M4	X .7 X	16MM	HEX SL

### ITEM NUMBER ----- DESCRIPTION -----

50M040070K020	M4	X .7 X	20MM	HEX SL
50M040070K025	M4	X .7 X	25MM	HEX SL
50M040070K030	M4	X .7 X	30MM	HEX SL
50M040070K035	M4	X .7 X	35MM	HEX SL
50M040070K040	M4	X .7 X	40MM	HEX SL
50M050080K006	M5	X .8 X	6MM	HEX SL
50M050080K008	M5	X .8 X	8MM	HEX SL
50M050080K010	M5	X .8 X	10MM	HEX SL
50M050080K012	M5	X .8 X	12MM	HEX SL
50M050080K016	M5	X .8 X	16MM	HEX SL
50M050080K020	M5	X .8 X	20MM	HEX SL
50M050080K025	M5	X .8 X	25MM	HEX SL
50M050080K030	M5	X .8 X	30MM	HEX SL
50M050080K035	M5	X .8 X	35MM	HEX SL
50M050080K040	M5	X .8 X	40MM	HEX SL
50M060100K005	M6	X 1.00 X	5MM	HEX SL
50M060100K008	M6	X 1.00 X	8MM	HEX SL
50M060100K010	M6	X 1.00 X	10MM	HEX SL
50M060100K012	M6	X 1.00 X	12MM	HEX SL
50M060100K016	M6	X 1.00 X	16MM	HEX SL
50M060100K020	M6	X 1.00 X	20MM	HEX SL
50M060100K025	M6	X 1.00 X	25MM	HEX SL
50M060100K030	M6	X 1.00 X	30MM	HEX SL
50M060100K035	M6	X 1.00 X	35MM	HEX SL
50M060100K040	M6	X 1.00 X	40MM	HEX SL
50M060100K045	M6	X 1.00 X	45MM	HEX SL
50M060100K050	M6	X 1.00 X	50MM	HEX SL
50M060100K060	M6	X 1.00 X	60MM	HEX SL
50M060100K070	M6	X 1.00 X	70MM	HEX SL
50M060100K075	M6	X 1.00 X	75MM	HEX SL
50M080125K010	M8	X 1.25 X	10MM	HEX SL
50M080125K016	M8	X 1.25 X	16MM	HEX SL
50M080125K020	M8	X 1.25 X	20MM	HEX SL
50M080125K025	M8	X 1.25 X	25MM	HEX SL
50M080125K030	M8	X 1.25 X	30MM	HEX SL
50M080125K035	M8	X 1.25 X	35MM	HEX SL
50M080125K040	M8	X 1.25 X	40MM	HEX SL
50M080125K050	M8	X 1.25 X	50MM	HEX SL
50M080125K070	M8	X 1.25 X	70MM	HEX SL
50M100150K016	M10	X 1.50 X	16MM	HEX SL
50M100150K020	M10	X 1.50 X	20MM	HEX SL
50M100150K025	M10	X 1.50 X	25MM	HEX SL
50M100150K030	M10	X 1.50 X	30MM	HEX SL
50M100150K035	M10	X 1.50 X	35MM	HEX SL
50M100150K050	M10	X 1.50 X	50MM	HEX SL
50M100150K060	M10	X 1.50 X	60MM	HEX SL



# METRIC SCREWS, BOLTS AND THREADED ROD

ALL DIMENSIONS ARE IN MILLIMETERS

SECTION  
**XIII**

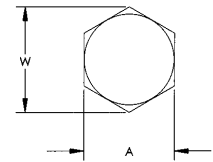
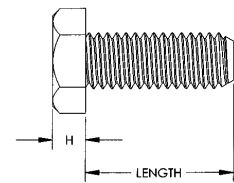

**HEX**

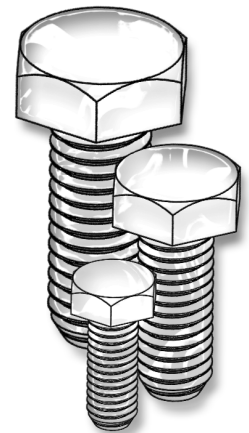

ITEM NUMBER	-----	DESCRIPTION	-----
50M020040J004	M2	X .4 X 4MM	HEX
50M020040J005	M2	X .4 X 5MM	HEX
50M020040J006	M2	X .4 X 6MM	HEX
50M020040J008	M2	X .4 X 8MM	HEX
50M020040J010	M2	X .4 X 10MM	HEX
50M020040J012	M2	X .4 X 12MM	HEX
50M020040J016	M2	X .4 X 16MM	HEX
50M020040J020	M2	X .4 X 20MM	HEX
50M020040J025	M2	X .4 X 25MM	HEX
50M025045J004	M2.5	X .45 X 4MM	HEX
50M025045J005	M2.5	X .45 X 5MM	HEX
50M025045J006	M2.5	X .45 X 6MM	HEX
50M025045J008	M2.5	X .45 X 8MM	HEX
50M025045J010	M2.5	X .45 X 10MM	HEX
50M025045J012	M2.5	X .45 X 12MM	HEX
50M025045J016	M2.5	X .45 X 16MM	HEX
50M025045J020	M2.5	X .45 X 20MM	HEX
50M025045J025	M2.5	X .45 X 25MM	HEX
50M030050J004	M3	X .5 X 4MM	HEX
50M030050J005	M3	X .5 X 5MM	HEX
50M030050J006	M3	X .5 X 6MM	HEX
50M030050J008	M3	X .5 X 8MM	HEX
50M030050J010	M3	X .5 X 10MM	HEX
50M030050J012	M3	X .5 X 12MM	HEX
50M030050J016	M3	X .5 X 16MM	HEX
50M030050J020	M3	X .5 X 20MM	HEX
50M030050J025	M3	X .5 X 25MM	HEX
50M030050J030	M3	X .5 X 30MM	HEX
50M030050J035	M3	X .5 X 35MM	HEX
50M030050J042	M3	X .5 X 42MM	HEX
50M035060J005	M3.5	X .6 X 5MM	HEX
50M035060J006	M3.5	X .6 X 6MM	HEX
50M035060J007	M3.5	X .6 X 7MM	HEX
50M035060J008	M3.5	X .6 X 8MM	HEX
50M035060J010	M3.5	X .6 X 10MM	HEX
50M035060J012	M3.5	X .6 X 12MM	HEX
50M035060J016	M3.5	X .6 X 16MM	HEX
50M035060J020	M3.5	X .6 X 20MM	HEX
50M035060J025	M3.5	X .6 X 25MM	HEX
50M035060J035	M3.5	X .6 X 35MM	HEX
50M035060J042	M3.5	X .6 X 42MM	HEX
50M040070J006	M4	X .7 X 6MM	HEX
50M040070J008	M4	X .7 X 8MM	HEX
50M040070J010	M4	X .7 X 10MM	HEX
50M040070J012	M4	X .7 X 12MM	HEX
50M040070J016	M4	X .7 X 16MM	HEX
50M040070J020	M4	X .7 X 20MM	HEX
50M040070J025	M4	X .7 X 25MM	HEX
50M040070J030	M4	X .7 X 30MM	HEX
50M040070J035	M4	X .7 X 35MM	HEX
50M040070J040	M4	X .7 X 40MM	HEX
50M050080J006	M5	X .8 X 6MM	HEX

ITEM NUMBER	-----	DESCRIPTION	-----
50M050080J008	M5	X .8 X 8MM	HEX
50M050080J010	M5	X .8 X 10MM	HEX
50M050080J012	M5	X .8 X 12MM	HEX
50M050080J014	M5	X .8 X 14MM	HEX
50M050080J016	M5	X .8 X 16MM	HEX
50M050080J020	M5	X .8 X 20MM	HEX
50M050080J025	M5	X .8 X 25MM	HEX
50M050080J030	M5	X .8 X 30MM	HEX
50M050080J035	M5	X .8 X 35MM	HEX
50M050080J040	M5	X .8 X 40MM	HEX
50M050080J070	M5	X .8 X 70MM	HEX
50M060100J005	M6	X 1.00 X 5MM	HEX
50M060100J008	M6	X 1.00 X 8MM	HEX
50M060100J010	M6	X 1.00 X 10MM	HEX
50M060100J012	M6	X 1.00 X 12MM	HEX
50M060100J016	M6	X 1.00 X 16MM	HEX
50M060100J020	M6	X 1.00 X 20MM	HEX
50M060100J025	M6	X 1.00 X 25MM	HEX
50M060100J030	M6	X 1.00 X 30MM	HEX
50M060100J035	M6	X 1.00 X 35MM	HEX
50M060100J040	M6	X 1.00 X 40MM	HEX
50M060100J045	M6	X 1.00 X 45MM	HEX
50M060100J050	M6	X 1.00 X 50MM	HEX
50M060100J060	M6	X 1.00 X 60MM	HEX
50M060100J070	M6	X 1.00 X 70MM	HEX
50M060100J075	M6	X 1.00 X 75MM	HEX
50M080125J006	M8	X 1.25 X 6MM	HEX
50M080125J010	M8	X 1.25 X 10MM	HEX
50M080125J016	M8	X 1.25 X 16MM	HEX
50M080125J020	M8	X 1.25 X 20MM	HEX
50M080125J025	M8	X 1.25 X 25MM	HEX
50M080125J030	M8	X 1.25 X 30MM	HEX
50M080125J035	M8	X 1.25 X 35MM	HEX
50M080125J040	M8	X 1.25 X 40MM	HEX
50M080125J050	M8	X 1.25 X 50MM	HEX
50M080125J070	M8	X 1.25 X 70MM	HEX
50M100150J016	M10	X 1.50 X 16MM	HEX
50M100150J020	M10	X 1.50 X 20MM	HEX
50M100150J025	M10	X 1.50 X 25MM	HEX
50M100150J030	M10	X 1.50 X 30MM	HEX
50M100150J035	M10	X 1.50 X 35MM	HEX
50M100150J050	M10	X 1.50 X 50MM	HEX
50M100150J060	M10	X 1.50 X 60MM	HEX
50M120125J012	M12	X 1.25 X 12MM	HEX
50M120175J020	M12	X 1.75 X 20MM	HEX
50M120175J025	M12	X 1.75 X 25MM	HEX
50M120175J030	M12	X 1.75 X 30MM	HEX
50M120175J035	M12	X 1.75 X 35MM	HEX
50M120175J040	M12	X 1.75 X 40MM	HEX
50M120175J050	M12	X 1.75 X 50MM	HEX
50M120175J060	M12	X 1.75 X 60MM	HEX

Nominal Screw Length	Tolerance On Length mm
to 3 mm incl.	0.2
over 3 to 10 mm	0.3
over 10 to 16 mm	0.4
over 16 to 50 mm	0.5
over 50 mm	1.0

All tolerances are plus and minus.

THREAD SIZE	A	H	W
M2	3.02 - 3.20	1.3 - 1.6	3.38 min.
M2.5	3.82 - 4.00	1.8 - 2.1	4.28 min.
M3	4.82 - 5.00	2.0 - 2.3	5.40 min.
M3.5	5.32 - 5.50	2.3 - 2.6	5.96 min.
M4	6.78 - 7.00	2.6 - 3.0	7.59 min.
M5	7.78 - 8.00	3.3 - 3.8	8.71 min.
M6	9.78 - 10.00	4.1 - 4.7	10.95 min.
M8	12.73 - 13.00	5.2 - 6.0	14.26 min.
M10	15.73 - 16.00	6.5 - 7.5	17.62 min.
M12	17.73 - 18.00	7.8 - 9.0	19.86 min.



# METRIC SCREWS, BOLTS AND THREADED ROD

SECTION  
**XIII**



ALL DIMENSIONS ARE IN MILLIMETERS

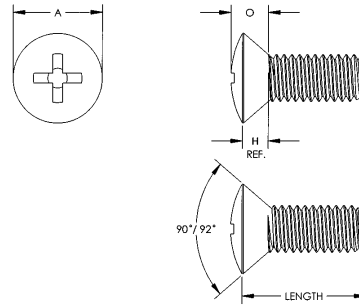

## OVAL PHILLIPS

ITEM NUMBER ----- DESCRIPTION -----

50M025045M004	M2.5 X .45 X 4MM	Oval Phil
50M025045M005	M2.5 X .45 X 5MM	Oval Phil
50M025045M006	M2.5 X .45 X 6MM	Oval Phil
50M025045M008	M2.5 X .45 X 8MM	Oval Phil
50M025045M010	M2.5 X .45 X 10MM	Oval Phil
50M025045M012	M2.5 X .45 X 12MM	Oval Phil
50M025045M016	M2.5 X .45 X 16MM	Oval Phil
50M025045M020	M2.5 X .45 X 20MM	Oval Phil
50M025045M025	M2.5 X .45 X 25MM	Oval Phil
50M030050M005	M3 X .5 X 5MM	Oval Phil
50M030050M006	M3 X .5 X 6MM	Oval Phil
50M030050M008	M3 X .5 X 8MM	Oval Phil
50M030050M010	M3 X .5 X 10MM	Oval Phil
50M030050M012	M3 X .5 X 12MM	Oval Phil
50M030050M016	M3 X .5 X 16MM	Oval Phil
50M030050M020	M3 X .5 X 20MM	Oval Phil
50M030050M025	M3 X .5 X 25MM	Oval Phil
50M035060M005	M3.5 X .6 X 5MM	Oval Phil
50M035060M006	M3.5 X .6 X 6MM	Oval Phil
50M035060M008	M3.5 X .6 X 8MM	Oval Phil
50M035060M010	M3.5 X .6 X 10MM	Oval Phil
50M035060M012	M3.5 X .6 X 12MM	Oval Phil
50M035060M016	M3.5 X .6 X 16MM	Oval Phil
50M035060M020	M3.5 X .6 X 20MM	Oval Phil
50M035060M025	M3.5 X .6 X 25MM	Oval Phil
50M035060M035	M3.5 X .6 X 35MM	Oval Phil
50M040070M006	M4 X .7 X 6MM	Oval Phil
50M040070M008	M4 X .7 X 8MM	Oval Phil
50M040070M010	M4 X .7 X 10MM	Oval Phil
50M040070M012	M4 X .7 X 12MM	Oval Phil

ITEM NUMBER ----- DESCRIPTION -----

50M040070M016	M4 X .7 X 16MM	Oval Phil
50M040070M020	M4 X .7 X 20MM	Oval Phil
50M040070M025	M4 X .7 X 25MM	Oval Phil
50M050080M006	M5 X .8 X 6MM	Oval Phil
50M050080M008	M5 X .8 X 8MM	Oval Phil
50M050080M010	M5 X .8 X 10MM	Oval Phil
50M050080M012	M5 X .8 X 12MM	Oval Phil
50M050080M016	M5 X .8 X 16MM	Oval Phil
50M050080M020	M5 X .8 X 20MM	Oval Phil
50M050080M025	M5 X .8 X 25MM	Oval Phil
50M050080M030	M5 X .8 X 30MM	Oval Phil
50M050080M040	M5 X .8 X 40MM	Oval Phil
50M060100M008	M6 X 1.00 X 8MM	Oval Phil
50M060100M010	M6 X 1.00 X 10MM	Oval Phil
50M060100M012	M6 X 1.00 X 12MM	Oval Phil
50M060100M016	M6 X 1.00 X 16MM	Oval Phil
50M060100M020	M6 X 1.00 X 20MM	Oval Phil
50M060100M025	M6 X 1.00 X 25MM	Oval Phil
50M060100M035	M6 X 1.00 X 35MM	Oval Phil
50M060100M045	M6 X 1.00 X 45MM	Oval Phil
50M080125M010	M8 X 1.25 X 10MM	Oval Phil
50M080125M016	M8 X 1.25 X 16MM	Oval Phil
50M080125M020	M8 X 1.25 X 20MM	Oval Phil
50M080125M025	M8 X 1.25 X 25MM	Oval Phil
50M080125M030	M8 X 1.25 X 30MM	Oval Phil
50M080125M050	M8 X 1.25 X 50MM	Oval Phil
50M100150M020	M10 X 1.5 X 20MM	Oval Phil
50M100150M025	M10 X 1.5 X 25MM	Oval Phil
50M100150M035	M10 X 1.5 X 35MM	Oval Phil



THREAD SIZE	A	H	O
M2 X 0.4	3.5 - 4.4	1.2 max ref.	1.7 max
M2.5 X 0.45	4.4 - 5.5	1.5 max ref.	2.1 max
M3 X 0.5	5.2 - 6.3	1.7 max ref.	2.4 max
M3.5 X 0.6	6.9 - 8.2	2.3 max ref.	3.1 max
M4 X 0.7	8.0 - 9.4	2.7 max ref.	3.7 max
M5 X 0.8	8.9 - 10.4	2.7 max ref.	3.9 max
M6 X 1	10.9 - 12.6	3.3 max ref.	4.7 max
M8 X 1.25	15.4 - 17.3	4.6 max ref.	6.6 max
M10 X 1.5	17.8 - 20.0	5.0 max ref.	7.3 max

Nominal Screw Length	Tolerance On Length
to 3 mm incl.	0.2
over 3 to 10 mm	0.3
over 10 to 16 mm	0.4
over 16 to 50 mm	0.5
over 50 mm	1.0

All tolerances are plus and minus.

# METRIC SCREWS, BOLTS AND THREADED ROD

SECTION  
**XIII**

ALL DIMENSIONS ARE IN MILLIMETERS

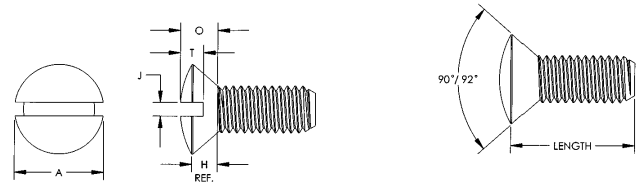
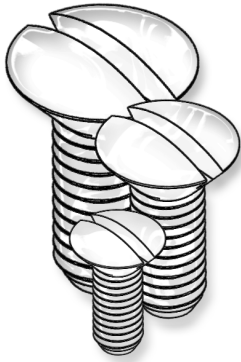

Nominal Screw Length	Tolerance On Length
to 3 mm incl.	0.2
over 3 to 10 mm	0.3
over 10 to 16 mm	0.4
over 16 to 50 mm	0.5
over 50 mm	1.0

All tolerances are plus and minus.

THREAD SIZE	A	H	O	J	T
M2 X 0.4	3.5 - 4.4	1.2 max ref.	1.7 max	0.5 - 0.7	0.8 - 1.0
M2.5 X 0.45	4.4 - 5.5	1.5 max ref.	2.1 max	0.6 - 0.8	1.0 - 1.2
M3 X 0.5	5.2 - 6.3	1.7 max ref.	2.4 max	0.8 - 1.0	1.2 - 1.5
M3.5 X 0.6	6.9 - 8.2	2.3 max ref.	3.1 max	1.0 - 1.2	1.4 - 1.7
M4 X 0.7	8.0 - 9.4	2.7 max ref.	3.7 max	1.2 - 1.5	1.6 - 1.9
M5 X 0.8	8.9 - 10.4	2.7 max ref.	3.9 max	1.2 - 1.5	2.0 - 2.4
M6 X 1	10.9 - 12.6	3.3 max ref.	4.7 max	1.6 - 1.9	2.4 - 2.8
M8 X 1.25	15.4 - 17.3	4.6 max ref.	6.6 max	2.0 - 2.3	3.2 - 3.7
M10 X 1.5	17.8 - 20.0	5.0 max ref.	7.3 max	2.5 - 2.8	3.8 - 4.4

## OVAL SLOTTED

ITEM NUMBER	DESCRIPTION
50M020040L004	M2 X .4 X 4MM Oval Slot
50M020040L005	M2 X .4 X 5MM Oval Slot
50M020040L006	M2 X .4 X 6MM Oval Slot
50M020040L008	M2 X .4 X 8MM Oval Slot
50M020040L010	M2 X .4 X 10MM Oval Slot
50M020040L011	M2 X .4 X 11MM Oval Slot
50M020040L012	M2 X .4 X 12MM Oval Slot
50M020040L016	M2 X .4 X 16MM Oval Slot
50M020040L025	M2 X .4 X 25MM Oval Slot
50M025045L004	M2.5 X .45 X 4MM Oval Slot
50M025045L005	M2.5 X .45 X 5MM Oval Slot
50M025045L006	M2.5 X .45 X 6MM Oval Slot
50M025045L008	M2.5 X .45 X 8MM Oval Slot
50M025045L010	M2.5 X .45 X 10MM Oval Slot
50M025045L012	M2.5 X .45 X 12MM Oval Slot
50M025045L016	M2.5 X .45 X 16MM Oval Slot
50M025045L020	M2.5 X .45 X 20MM Oval Slot
50M025045L025	M2.5 X .5 X 25MM Oval Slot
50M030050L005	M3 X .5 X 5MM Oval Slot
50M030050L006	M3 X .5 X 6MM Oval Slot
50M030050L008	M3 X .5 X 8MM Oval Slot
50M030050L010	M3 X .5 X 10MM Oval Slot
50M030050L012	M3 X .5 X 12MM Oval Slot
50M030050L015	M3 X .5 X 15MM Oval Slot
50M030050L016	M3 X .5 X 16MM Oval Slot
50M030050L020	M3 X .5 X 20MM Oval Slot
50M030050L025	M3 X .5 X 25MM Oval Slot
50M030050L030	M3 X .5 X 30MM Oval Slot
50M030050L042	M3 X .5 X 42MM Oval Slot
50M035060L005	M3.5 X .6 X 5MM Oval Slot
50M035060L006	M3.5 X .6 X 6MM Oval Slot
50M035060L008	M3.5 X .6 X 8MM Oval Slot
50M035060L010	M3.5 X .6 X 10MM Oval Slot
50M035060L016	M3.5 X .6 X 16MM Oval Slot
50M035060L020	M3.5 X .6 X 20MM Oval Slot
50M035060L025	M3.5 X .6 X 25MM Oval Slot
50M035060L035	M3.5 X .6 X 35MM Oval Slot
50M040070L006	M4 X .7 X 6MM Oval Slot
50M040070L008	M4 X .7 X 8MM Oval Slot
50M040070L010	M4 X .7 X 10MM Oval Slot

ITEM NUMBER	DESCRIPTION
50M040070L012	M4 X .7 X 12MM Oval Slot
50M040070L015	M4 X .7 X 15MM Oval Slot
50M040070L016	M4 X .7 X 16MM Oval Slot
50M040070L020	M4 X .7 X 20MM Oval Slot
50M040070L025	M4 X .7 X 25MM Oval Slot
50M040070L030	M4 X .7 X 30MM Oval Slot
50M040070L035	M4 X .7 X 35MM Oval Slot
50M050080L006	M5 X .8 X 6MM Oval Slot
50M050080L008	M5 X .8 X 8MM Oval Slot
50M050080L010	M5 X .8 X 10MM Oval Slot
50M050080L012	M5 X .8 X 12MM Oval Slot
50M050080L015	M5 X .8 X 15MM Oval Slot
50M050080L016	M5 X .8 X 16MM Oval Slot
50M050080L020	M5 X .8 X 20MM Oval Slot
50M050080L025	M5 X .8 X 25MM Oval Slot
50M050080L030	M5 X .8 X 30MM Oval Slot
50M050080L035	M5 X .8 X 35MM Oval Slot
50M050080L040	M5 X .8 X 40MM Oval Slot
50M060100L008	M6 X 1.0 X 8MM Oval Slot
50M060100L010	M6 X 1.0 X 10MM Oval Slot
50M060100L012	M6 X 1.0 X 12MM Oval Slot
50M060100L016	M6 X 1.0 X 16MM Oval Slot
50M060100L020	M6 X 1.0 X 20MM Oval Slot
50M060100L025	M6 X 1.0 X 25MM Oval Slot
50M060100L035	M6 X 1.0 X 35MM Oval Slot
50M060100L040	M6 X 1.0 X 40MM Oval Slot
50M060100L045	M6 X 1.0 X 45MM Oval Slot
50M060100L050	M6 X 1.0 X 50MM Oval Slot
50M080125L016	M8 X 1.25 X 16MM Oval Slot
50M080125L020	M8 X 1.25 X 20MM Oval Slot
50M080125L025	M8 X 1.25 X 25MM Oval Slot
50M080125L030	M8 X 1.25 X 30MM Oval Slot
50M080125L050	M8 X 1.25 X 50MM Oval Slot
50M100150L020	M10 X 1.5 X 20MM Oval Slot
50M100150L025	M10 X 1.5 X 25MM Oval Slot
50M100150L030	M10 X 1.5 X 30MM Oval Slot
50M100150L035	M10 X 1.5 X 35MM Oval Slot
50M100150L060	M10 X 1.5 X 60MM Oval Slot

# METRIC SCREWS, BOLTS AND THREADED ROD

SECTION  
**XIII**

ALL DIMENSIONS ARE IN MILLIMETERS

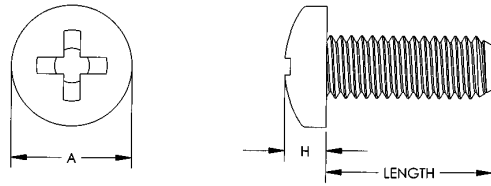

## PAN PHILLIPS

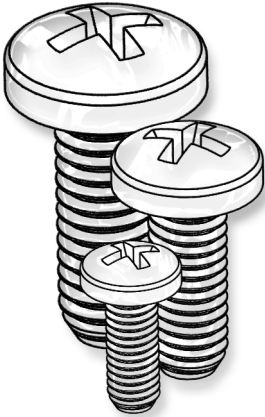

THREAD SIZE	A	H
M2	3.7 - 4.0	1.4 - 1.6
M2.5	4.7 - 5.0	1.9 - 2.1
M3	5.3 - 5.6	2.2 - 2.4
M3.5	6.6 - 7.0	2.3 - 2.6
M4	7.6 - 8.0	2.8 - 3.1
M5	9.1 - 9.5	3.4 - 3.7
M6	11.5 - 12.0	4.3 - 4.6
M8	15.5 - 16.0	5.6 - 6.0
M10	19.4 - 20.0	7.1 - 7.5

Nominal Screw Length	Tolerance On Length
to 3 mm incl.	0.2
over 3 to 10 mm	0.3
over 10 to 16 mm	0.4
over 16 to 50 mm	0.5
over 50 mm	1.0

All tolerances are plus and minus.

ITEM NUMBER	DESCRIPTION
50M020040P004	M2 X .4 X 4MM Pan Phil
50M020040P005	M2 X .4 X 5MM Pan Phil
50M020040P006	M2 X .4 X 6MM Pan Phil
50M020040P008	M2 X .4 X 8MM Pan Phil
50M020040P010	M2 X .4 X 10MM Pan Phil
50M020040P012	M2 X .4 X 12MM Pan Phil
50M020040P016	M2 X .4 X 16MM Pan Phil
50M020040P020	M2 X .4 X 20MM Pan Phil
50M020040P025	M2 X .4 X 25MM Pan Phil
50M025045P004	M2.5 X .45 X 4MM Pan Phil
50M025045P005	M2.5 X .45 X 5MM Pan Phil
50M025045P006	M2.5 X .45 X 6MM Pan Phil
50M025045P008	M2.5 X .45 X 8MM Pan Phil
50M025045P010	M2.5 X .45 X 10MM Pan Phil
50M025045P012	M2.5 X .45 X 12MM Pan Phil
50M025045P016	M2.5 X .45 X 16MM Pan Phil
50M025045P020	M2.5 X .45 X 20MM Pan Phil
50M025045P025	M2.5 X .45 X 25MM Pan Phil
50M030050P003	M3 X .5 X 3MM Pan Phil
50M030050P004	M3 X .5 X 4MM Pan Phil
50M030050P005	M3 X .5 X 5MM Pan Phil
50M030050P006	M3 X .5 X 6MM Pan Phil
50M030050P008	M3 X .5 X 8MM Pan Phil
50M030050P010	M3 X .5 X 10MM Pan Phil
50M030050P012	M3 X .5 X 12MM Pan Phil
50M030050P016	M3 X .5 X 16MM Pan Phil
50M030050P020	M3 X .5 X 20MM Pan Phil
50M030050P025	M3 X .5 X 25MM Pan Phil
50M030050P030	M3 X .5 X 30MM Pan Phil
50M030050P035	M3 X .5 X 35MM Pan Phil
50M030050P042	M3 X .5 X 42MM Pan Phil
50M035060P005	M3.5 X .6 X 5MM Pan Phil
50M035060P006	M3.5 X .6 X 6MM Pan Phil
50M035060P007	M3.5 X .6 X 7MM Pan Phil
50M035060P008	M3.5 X .6 X 8MM Pan Phil
50M035060P010	M3.5 X .6 X 10MM Pan Phil
50M035060P012	M3.5 X .6 X 12MM Pan Phil
50M035060P016	M3.5 X .6 X 16MM Pan Phil
50M035060P020	M3.5 X .6 X 20MM Pan Phil
50M035060P025	M3.5 X .6 X 25MM Pan Phil
50M035060P035	M3.5 X .6 X 35MM Pan Phil
50M035060P042	M3.5 X .6 X 42MM Pan Phil
50M040070P003	M4 X .7 X 3MM Pan Phil
50M040070P006	M4 X .7 X 6MM Pan Phil
50M040070P008	M4 X .7 X 8MM Pan Phil
50M040070P010	M4 X .7 X 10MM Pan Phil
50M040070P012	M4 X .7 X 12MM Pan Phil
50M040070P016	M4 X .7 X 16MM Pan Phil
50M040070P020	M4 X .7 X 20MM Pan Phil

ITEM NUMBER	DESCRIPTION
50M040070P025	M4 X .7 X 25MM Pan Phil
50M040070P030	M4 X .7 X 30MM Pan Phil
50M040070P035	M4 X .7 X 35MM Pan Phil
50M040070P040	M4 X .7 X 40MM Pan Phil
50M050080P006	M5 X .8 X 6MM Pan Phil
50M050080P008	M5 X .8 X 8MM Pan Phil
50M050080P010	M5 X .8 X 10MM Pan Phil
50M050080P012	M5 X .8 X 12MM Pan Phil
50M050080P015	M5 X .8 X 15MM Pan Phil
50M050080P016	M5 X .8 X 16MM Pan Phil
50M050080P020	M5 X .8 X 20MM Pan Phil
50M050080P025	M5 X .8 X 25MM Pan Phil
50M050080P030	M5 X .8 X 30MM Pan Phil
50M050080P035	M5 X .8 X 35MM Pan Phil
50M050080P040	M5 X .8 X 40MM Pan Phil
50M060100P005	M6 X 1.00 X 5MM Pan Phil
50M060100P008	M6 X 1.00 X 8MM Pan Phil
50M060100P010	M6 X 1.00 X 10MM Pan Phil
50M060100P012	M6 X 1.00 X 12MM Pan Phil
50M060100P016	M6 X 1.00 X 16MM Pan Phil
50M060100P020	M6 X 1.00 X 20MM Pan Phil
50M060100P022	M6 X 1.00 X 22MM Pan Phil
50M060100P025	M6 X 1.00 X 25MM Pan Phil
50M060100P030	M6 X 1.00 X 30MM Pan Phil
50M060100P035	M6 X 1.00 X 35MM Pan Phil
50M060100P040	M6 X 1.00 X 40MM Pan Phil
50M060100P045	M6 X 1.00 X 45MM Pan Phil
50M060100P050	M6 X 1.00 X 50MM Pan Phil
50M060100P060	M6 X 1.00 X 60MM Pan Phil
50M060100P070	M6 X 1.00 X 70MM Pan Phil
50M060100P075	M6 X 1.00 X 75MM Pan Phil
50M080125P010	M8 X 1.25 X 10MM Pan Phil
50M080125P016	M8 X 1.25 X 16MM Pan Phil
50M080125P020	M8 X 1.25 X 20MM Pan Phil
50M080125P025	M8 X 1.25 X 25MM Pan Phil
50M080125P030	M8 X 1.25 X 30MM Pan Phil
50M080125P035	M8 X 1.25 X 35MM Pan Phil
50M080125P050	M8 X 1.25 X 50MM Pan Phil
50M080125P070	M8 X 1.25 X 70MM Pan Phil
50M100150P013	M10 X 1.50 X 13MM Pan Phil
50M100150P016	M10 X 1.50 X 16MM Pan Phil
50M100150P019	M10 X 1.50 X 19MM Pan Phil
50M100150P020	M10 X 1.50 X 20MM Pan Phil
50M100150P025	M10 X 1.50 X 25MM Pan Phil
50M100150P030	M10 X 1.50 X 30MM Pan Phil
50M100150P035	M10 X 1.50 X 35MM Pan Phil
50M100150P050	M10 X 1.50 X 50MM Pan Phil
50M100150P060	M10 X 1.50 X 60MM Pan Phil



# METRIC SCREWS, BOLTS AND THREADED ROD

SECTION  
**XIII**

ALL DIMENSIONS ARE IN MILLIMETERS

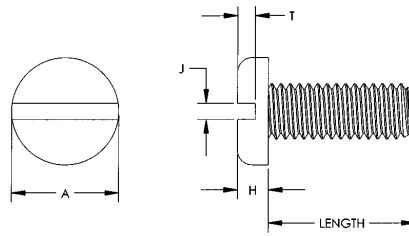

## PAN SLOTTED

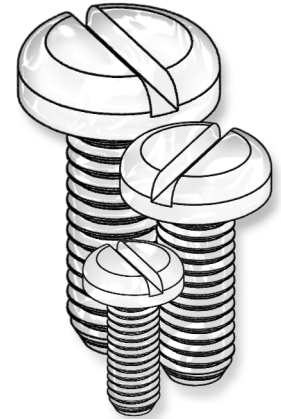

ITEM NUMBER	DESCRIPTION
50M020040N004	M2 X .4 X 4MM Pan Slot
50M020040N003	M2 X .4 X 3MM Pan Slot
50M020040N005	M2 X .4 X 5MM Pan Slot
50M020040N006	M2 X .4 X 6MM Pan Slot
50M020040N008	M2 X .4 X 8MM Pan Slot
50M020040N010	M2 X .4 X 10MM Pan Slot
50M020040N012	M2 X .4 X 12MM Pan Slot
50M020040N016	M2 X .4 X 16MM Pan Slot
50M020040N020	M2 X .4 X 20MM Pan Slot
50M020040N025	M2 X .4 X 25MM Pan Slot
50M025045N004	M2.5 X .45 X 4MM Pan Slot
50M025045N005	M2.5 X .45 X 5MM Pan Slot
50M025045N006	M2.5 X .45 X 6MM Pan Slot
50M025045N008	M2.5 X .45 X 8MM Pan Slot
50M025045N010	M2.5 X .45 X 10MM Pan Slot
50M025045N012	M2.5 X .45 X 12MM Pan Slot
50M025045N016	M2.5 X .45 X 16MM Pan Slot
50M025045N020	M2.5 X .45 X 20MM Pan Slot
50M025045N025	M2.5 X .45 X 25MM Pan Slot
50M030050N004	M3 X .5 X 4MM Pan Slot
50M030050N005	M3 X .5 X 5MM Pan Slot
50M030050N006	M3 X .5 X 6MM Pan Slot
50M030050N008	M3 X .5 X 8MM Pan Slot
50M030050N010	M3 X .5 X 10MM Pan Slot
50M030050N012	M3 X .5 X 12MM Pan Slot
50M030050N016	M3 X .5 X 16MM Pan Slot
50M030050N020	M3 X .5 X 20MM Pan Slot
50M030050N025	M3 X .5 X 25MM Pan Slot
50M030050N030	M3 X .5 X 30MM Pan Slot
50M030050N035	M3 X .5 X 35MM Pan Slot
50M030050N042	M3 X .5 X 42MM Pan Slot
50M035060N005	M3.5 X .6 X 5MM Pan Slot
50M035060N006	M3.5 X .6 X 6MM Pan Slot
50M035060N007	M3.5 X .6 X 7MM Pan Slot
50M035060N008	M3.5 X .6 X 8MM Pan Slot
50M035060N010	M3.5 X .6 X 10MM Pan Slot
50M035060N012	M3.5 X .6 X 12MM Pan Slot
50M035060N016	M3.5 X .6 X 16MM Pan Slot
50M035060N020	M3.5 X .6 X 20MM Pan Slot
50M035060N025	M3.5 X .6 X 25MM Pan Slot
50M035060N035	M3.5 X .6 X 35MM Pan Slot
50M035060N042	M3.5 X .6 X 42MM Pan Slot
50M040070N003	M4 X .7 X 3MM Pan Slot
50M040070N006	M4 X .7 X 6MM Pan Slot
50M040070N008	M4 X .7 X 8MM Pan Slot
50M040070N010	M4 X .7 X 10MM Pan Slot
50M040070N012	M4 X .7 X 12MM Pan Slot
50M040070N016	M4 X .7 X 16MM Pan Slot
50M040070N020	M4 X .7 X 20MM Pan Slot

ITEM NUMBER	DESCRIPTION
50M040070N025	M4 X .7 X 25MM Pan Slot
50M040070N030	M4 X .7 X 30MM Pan Slot
50M040070N035	M4 X .7 X 35MM Pan Slot
50M040070N040	M4 X .7 X 40MM Pan Slot
50M050080N006	M5 X .8 X 6MM Pan Slot
50M050080N008	M5 X .8 X 8MM Pan Slot
50M050080N010	M5 X .8 X 10MM Pan Slot
50M050080N012	M5 X .8 X 12MM Pan Slot
50M050080N015	M5 X .8 X 15MM Pan Slot
50M050080N016	M5 X .8 X 16MM Pan Slot
50M050080N020	M5 X .8 X 20MM Pan Slot
50M050080N025	M5 X .8 X 25MM Pan Slot
50M050080N030	M5 X .8 X 30MM Pan Slot
50M050080N035	M5 X .8 X 35MM Pan Slot
50M050080N040	M5 X .8 X 40MM Pan Slot
50M060100N005	M6 X 1.00 X 5MM Pan Slot
50M060100N008	M6 X 1.00 X 8MM Pan Slot
50M060100N010	M6 X 1.00 X 10MM Pan Slot
50M060100N012	M6 X 1.00 X 12MM Pan Slot
50M060100N016	M6 X 1.00 X 16MM Pan Slot
50M060100N020	M6 X 1.00 X 20MM Pan Slot
50M060100N022	M6 X 1.00 X 22MM Pan Slot
50M060100N025	M6 X 1.00 X 25MM Pan Slot
50M060100N030	M6 X 1.00 X 30MM Pan Slot
50M060100N035	M6 X 1.00 X 35MM Pan Slot
50M060100N040	M6 X 1.00 X 40MM Pan Slot
50M060100N045	M6 X 1.00 X 45MM Pan Slot
50M060100N050	M6 X 1.00 X 50MM Pan Slot
50M060100N060	M6 X 1.00 X 60MM Pan Slot
50M060100N070	M6 X 1.00 X 70MM Pan Slot
50M060100N075	M6 X 1.00 X 75MM Pan Slot
50M080125N010	M8 X 1.25 X 10MM Pan Slot
50M080125N016	M8 X 1.25 X 16MM Pan Slot
50M080125N020	M8 X 1.25 X 20MM Pan Slot
50M080125N025	M8 X 1.25 X 25MM Pan Slot
50M080125N030	M8 X 1.25 X 30MM Pan Slot
50M080125N035	M8 X 1.25 X 35MM Pan Slot
50M080125N050	M8 X 1.25 X 50MM Pan Slot
50M080125N070	M8 X 1.25 X 70MM Pan Slot
50M100150N013	M10 X 1.50 X 13MM Pan Slot
50M100150N016	M10 X 1.50 X 16MM Pan Slot
50M100150N019	M10 X 1.50 X 19MM Pan Slot
50M100150N020	M10 X 1.50 X 20MM Pan Slot
50M100150N025	M10 X 1.50 X 25MM Pan Slot
50M100150N030	M10 X 1.50 X 30MM Pan Slot
50M100150N035	M10 X 1.50 X 35MM Pan Slot
50M100150N050	M10 X 1.50 X 50MM Pan Slot
50M100150N060	M10 X 1.50 X 60MM Pan Slot

THREAD SIZE	A	H	J	T
M2	3.7 - 4.0	1.1 - 1.3	0.5 - 0.7	0.5 min.
M2.5	4.7 - 5.0	1.3 - 1.5	0.6 - 0.8	0.6 min.
M3	5.3 - 5.6	1.6 - 1.8	0.8 - 1.0	0.7 min.
M3.5	6.6 - 7.0	1.9 - 2.1	1.0 - 1.2	0.8 min.
M4	7.6 - 8.0	2.2 - 2.4	1.2 - 1.5	1.0 min.
M5	9.1 - 9.5	2.7 - 3.0	1.2 - 1.5	1.2 min.
M6	11.5 - 12.0	3.3 - 3.6	1.6 - 1.9	1.4 min.
M8	15.5 - 16.0	4.5 - 4.8	2.0 - 2.3	1.9 min.
M10	19.4 - 20.0	5.7 - 6.0	2.5 - 2.8	2.4 min.

Nominal Screw Length	Tolerance On Length mm
to 3 mm incl.	0.2
over 3 to 10 mm	0.3
over 10 to 16 mm	0.4
over 16 to 50 mm	0.5
over 50 mm	1.0

All tolerances are plus and minus.



# METRIC SCREWS, BOLTS AND THREADED ROD

SECTION  
**XIII**

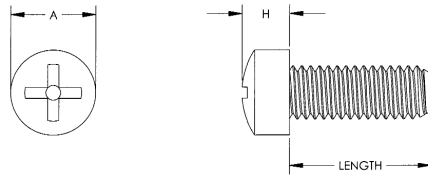

ALL DIMENSIONS ARE IN MILLIMETERS

## FILLISTER PHILLIPS



THREAD SIZE	A	H
M2 X 0.4	3.8	1.60
M2.5 X 0.45	5.0	2.00
M3 X 0.5	6.0	2.40
M3.5 X 0.6	7.0	2.70
M4 X 0.7	8.0	3.10
M5 X 0.8	10.0	3.80
M6 X 1.0	12.0	4.60
M8 X 1.25	16.0	6.00
M10 X 1.5	18.0	7.00

Nominal Screw Length	Tolerance On Length
to 3 mm incl.	0.2
over 3 to 10 mm	0.3
over 10 to 16 mm	0.4
over 16 to 50 mm	0.5
over 50 mm	1.0

All tolerances are plus and minus.



ITEM NUMBER	DESCRIPTION	ITEM NUMBER	DESCRIPTION
50M020040G004	M2 X .4 X 4MM Fill Phil	50M040070G025	M4 X .7 X 25MM Fill Phil
50M020040G005	M2 X .4 X 5MM Fill Phil	50M040070G030	M4 X .7 X 30MM Fill Phil
50M020040G006	M2 X .4 X 6MM Fill Phil	50M040070G035	M4 X .7 X 35MM Fill Phil
50M020040G008	M2 X .4 X 8MM Fill Phil	50M040070G040	M4 X .7 X 40MM Fill Phil
50M020040G010	M2 X .4 X 10MM Fill Phil	50M050080G006	M5 X .8 X 6MM Fill Phil
50M020040G012	M2 X .4 X 12MM Fill Phil	50M050080G008	M5 X .8 X 8MM Fill Phil
50M020040G016	M2 X .4 X 16MM Fill Phil	50M050080G010	M5 X .8 X 10MM Fill Phil
50M020040G020	M2 X .4 X 20MM Fill Phil	50M050080G012	M5 X .8 X 12MM Fill Phil
50M020040G025	M2 X .4 X 25MM Fill Phil	50M050080G015	M5 X .8 X 15MM Fill Phil
50M025045G004	M2.5 X .45 X 4MM Fill Phil	50M050080G016	M5 X .8 X 16MM Fill Phil
50M025045G005	M2.5 X .45 X 5MM Fill Phil	50M050080G020	M5 X .8 X 20MM Fill Phil
50M025045G006	M2.5 X .45 X 6MM Fill Phil	50M050080G025	M5 X .8 X 25MM Fill Phil
50M025045G008	M2.5 X .45 X 8MM Fill Phil	50M050080G030	M5 X .8 X 30MM Fill Phil
50M025045G010	M2.5 X .45 X 10MM Fill Phil	50M050080G035	M5 X .8 X 35MM Fill Phil
50M025045G012	M2.5 X .45 X 12MM Fill Phil	50M050080G040	M5 X .8 X 40MM Fill Phil
50M025045G016	M2.5 X .45 X 16MM Fill Phil	50M060100G005	M6 X 1.0 X 5MM Fill Phil
50M025045G020	M2.5 X .45 X 20MM Fill Phil	50M060100G008	M6 X 1.00 X 8MM Fill Phil
50M025045G025	M2.5 X .45 X 25MM Fill Phil	50M060100G010	M6 X 1.00 X 10MM Fill Phil
50M030050G004	M3 X .5 X 4MM Fill Phil	50M060100G012	M6 X 1.00 X 12MM Fill Phil
50M030050G005	M3 X .5 X 5MM Fill Phil	50M060100G016	M6 X 1.00 X 16MM Fill Phil
50M030050G006	M3 X .5 X 6MM Fill Phil	50M060100G020	M6 X 1.00 X 20MM Fill Phil
50M030050G008	M3 X .5 X 8MM Fill Phil	50M060100G022	M6 X 1.00 X 22MM Fill Phil
50M030050G010	M3 X .5 X 10MM Fill Phil	50M060100G025	M6 X 1.00 X 25MM Fill Phil
50M030050G012	M3 X .5 X 12MM Fill Phil	50M060100G030	M6 X 1.00 X 30MM Fill Phil
50M030050G016	M3 X .5 X 16MM Fill Phil	50M060100G035	M6 X 1.00 X 35MM Fill Phil
50M030050G020	M3 X .5 X 20MM Fill Phil	50M060100G040	M6 X 1.00 X 40MM Fill Phil
50M030050G025	M3 X .5 X 25MM Fill Phil	50M060100G045	M6 X 1.00 X 45MM Fill Phil
50M030050G030	M3 X .5 X 30MM Fill Phil	50M060100G050	M6 X 1.00 X 50MM Fill Phil
50M030050G035	M3 X .5 X 35MM Fill Phil	50M060100G060	M6 X 1.00 X 60MM Fill Phil
50M030050G042	M3 X .5 X 42MM Fill Phil	50M060100G070	M6 X 1.00 X 70MM Fill Phil
50M035060G005	M3.5 X .6 X 5MM Fill Phil	50M060100G075	M6 X 1.00 X 75MM Fill Phil
50M035060G006	M3.5 X .6 X 6MM Fill Phil	50M080125G010	M8 X 1.25 X 10MM Fill Phil
50M035060G007	M3.5 X .6 X 7MM Fill Phil	50M080125G016	M8 X 1.25 X 16MM Fill Phil
50M035060G008	M3.5 X .6 X 8MM Fill Phil	50M080125G020	M8 X 1.25 X 20MM Fill Phil
50M035060G010	M3.5 X .6 X 10MM Fill Phil	50M080125G025	M8 X 1.25 X 25MM Fill Phil
50M035060G012	M3.5 X .6 X 12MM Fill Phil	50M080125G030	M8 X 1.25 X 30MM Fill Phil
50M035060G016	M3.5 X .6 X 16MM Fill Phil	50M080125G035	M8 X 1.25 X 35MM Fill Phil
50M035060G020	M3.5 X .6 X 20MM Fill Phil	50M080125G050	M8 X 1.25 X 50MM Fill Phil
50M035060G025	M3.5 X .6 X 25MM Fill Phil	50M080125G070	M8 X 1.25 X 70MM Fill Phil
50M035060G035	M3.5 X .6 X 35MM Fill Phil	50M100150G013	M10 X 1.50 X 13MM Fill Phil
50M035060G042	M3.5 X .6 X 42MM Fill Phil	50M100150G016	M10 X 1.50 X 16MM Fill Phil
50M040070G003	M4 X .7 X 3MM Fill Phil	50M100150G019	M10 X 1.50 X 19MM Fill Phil
50M040070G006	M4 X .7 X 6MM Fill Phil	50M100150G020	M10 X 1.50 X 20MM Fill Phil
50M040070G008	M4 X .7 X 8MM Fill Phil	50M100150G025	M10 X 1.50 X 25MM Fill Phil
50M040070G010	M4 X .7 X 10MM Fill Phil	50M100150G030	M10 X 1.50 X 30MM Fill Phil
50M040070G012	M4 X .7 X 12MM Fill Phil	50M100150G035	M10 X 1.50 X 35MM Fill Phil
50M040070G016	M4 X .7 X 16MM Fill Phil	50M100150G050	M10 X 1.50 X 50MM Fill Phil
50M040070G020	M4 X .7 X 20MM Fill Phil	50M100150G060	M10 X 1.50 X 60MM Fill Phil



# METRIC SCREWS, BOLTS AND THREADED ROD

ALL DIMENSIONS ARE IN MILLIMETERS

SECTION  
**XIII**

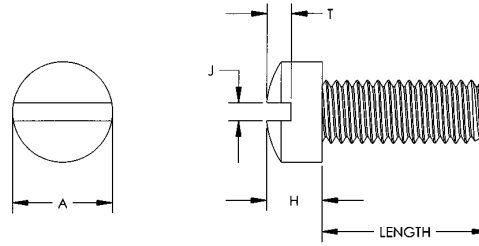

**FILLISTER SLOTTED**

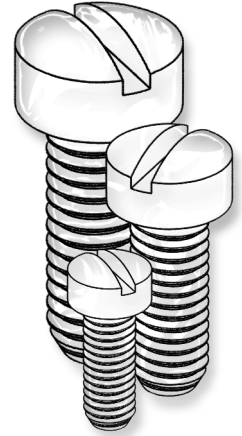

ITEM NUMBER	DESCRIPTION
50M020040F004	M2 X .4 X 4MM Fill Slot
50M020040F005	M2 X .4 X 5MM Fill Slot
50M020040F006	M2 X .4 X 6MM Fill Slot
50M020040F008	M2 X .4 X 8MM Fill Slot
50M020040F010	M2 X .4 X 10MM Fill Slot
50M020040F012	M2 X .4 X 12MM Fill Slot
50M020040F016	M2 X .4 X 16MM Fill Slot
50M020040F020	M2 X .4 X 20MM Fill Slot
50M020040F025	M2 X .4 X 25MM Fill Slot
50M025045F004	M2.5 X .45 X 4MM Fill Slot
50M025045F005	M2.5 X .45 X 5MM Fill Slot
50M025045F006	M2.5 X .45 X 6MM Fill Slot
50M025045F008	M2.5 X .45 X 8MM Fill Slot
50M025045F010	M2.5 X .45 X 10MM Fill Slot
50M025045F012	M2.5 X .45 X 12MM Fill Slot
50M025045F016	M2.5 X .45 X 16MM Fill Slot
50M025045F020	M2.5 X .45 X 20MM Fill Slot
50M025045F025	M2.5 X .45 X 25MM Fill Slot
50M030050F004	M3 X .5 X 4MM Fill Slot
50M030050F005	M3 X .5 X 5MM Fill Slot
50M030050F006	M3 X .5 X 6MM Fill Slot
50M030050F008	M3 X .5 X 8MM Fill Slot
50M030050F010	M3 X .5 X 10MM Fill Slot
50M030050F012	M3 X .5 X 12MM Fill Slot
50M030050F016	M3 X .5 X 16MM Fill Slot
50M030050F020	M3 X .5 X 20MM Fill Slot
50M030050F025	M3 X .5 X 25MM Fill Slot
50M030050F030	M3 X .5 X 30MM Fill Slot
50M030050F035	M3 X .5 X 35MM Fill Slot
50M030050F042	M3 X .5 X 42MM Fill Slot
50M035060F005	M3.5 X .6 X 5MM Fill Slot
50M035060F006	M3.5 X .6 X 6MM Fill Slot
50M035060F007	M3.5 X .6 X 7MM Fill Slot
50M035060F008	M3.5 X .6 X 8MM Fill Slot
50M035060F010	M3.5 X .6 X 10MM Fill Slot
50M035060F012	M3.5 X .6 X 12MM Fill Slot
50M035060F016	M3.5 X .6 X 16MM Fill Slot
50M035060F020	M3.5 X .6 X 20MM Fill Slot
50M035060F025	M3.5 X .6 X 25MM Fill Slot
50M035060F035	M3.5 X .6 X 35MM Fill Slot
50M035060F042	M3.5 X .6 X 42MM Fill Slot
50M040070F003	M4 X .7 X 3MM Fill Slot
50M040070F006	M4 X .7 X 6MM Fill Slot
50M040070F008	M4 X .7 X 8MM Fill Slot
50M040070F010	M4 X .7 X 10MM Fill Slot
50M040070F012	M4 X .7 X 12MM Fill Slot
50M040070F016	M4 X .7 X 16MM Fill Slot
50M040070F020	M4 X .7 X 20MM Fill Slot

ITEM NUMBER	DESCRIPTION
50M040070F025	M4 X .7 X 25MM Fill Slot
50M040070F030	M4 X .7 X 30MM Fill Slot
50M040070F035	M4 X .7 X 35MM Fill Slot
50M040070F040	M4 X .7 X 40MM Fill Slot
50M050080F006	M5 X .8 X 6MM Fill Slot
50M050080F008	M5 X .8 X 8MM Fill Slot
50M050080F010	M5 X .8 X 10MM Fill Slot
50M050080F012	M5 X .8 X 12MM Fill Slot
50M050080F015	M5 X .8 X 15MM Fill Slot
50M050080F016	M5 X .8 X 16MM Fill Slot
50M050080F020	M5 X .8 X 20MM Fill Slot
50M050080F025	M5 X .8 X 25MM Fill Slot
50M050080F030	M5 X .8 X 30MM Fill Slot
50M050080F035	M5 X .8 X 35MM Fill Slot
50M050080F040	M5 X .8 X 40MM Fill Slot
50M060100F005	M6 X 1.00 X 5MM Fill Slot
50M060100F008	M6 X 1.00 X 8MM Fill Slot
50M060100F010	M6 X 1.00 X 10MM Fill Slot
50M060100F012	M6 X 1.00 X 12MM Fill Slot
50M060100F016	M6 X 1.00 X 16MM Fill Slot
50M060100F020	M6 X 1.00 X 20MM Fill Slot
50M060100F022	M6 X 1.00 X 22MM Fill Slot
50M060100F025	M6 X 1.00 X 25MM Fill Slot
50M060100F030	M6 X 1.00 X 30MM Fill Slot
50M060100F035	M6 X 1.00 X 35MM Fill Slot
50M060100F040	M6 X 1.00 X 40MM Fill Slot
50M060100F045	M6 X 1.00 X 45MM Fill Slot
50M060100F050	M6 X 1.00 X 50MM Fill Slot
50M060100F060	M6 X 1.00 X 60MM Fill Slot
50M060100F070	M6 X 1.00 X 70MM Fill Slot
50M060100F075	M6 X 1.00 X 75MM Fill Slot
50M080125F010	M8 X 1.25 X 10MM Fill Slot
50M080125F016	M8 X 1.25 X 16MM Fill Slot
50M080125F020	M8 X 1.25 X 20MM Fill Slot
50M080125F025	M8 X 1.25 X 25MM Fill Slot
50M080125F030	M8 X 1.25 X 30MM Fill Slot
50M080125F035	M8 X 1.25 X 35MM Fill Slot
50M080125F050	M8 X 1.25 X 50MM Fill Slot
50M080125F070	M8 X 1.25 X 70MM Fill Slot
50M100150F013	M10 X 1.50 X 13MM Fill Slot
50M100150F016	M10 X 1.50 X 16MM Fill Slot
50M100150F019	M10 X 1.50 X 19MM Fill Slot
50M100150F020	M10 X 1.50 X 20MM Fill Slot
50M100150F025	M10 X 1.50 X 25MM Fill Slot
50M100150F030	M10 X 1.50 X 30MM Fill Slot
50M100150F035	M10 X 1.50 X 35MM Fill Slot
50M100150F050	M10 X 1.50 X 50MM Fill Slot
50M100150F060	M10 X 1.50 X 60MM Fill Slot

THREAD SIZE	A	H	J	T
M2 X 0.4	3.8	1.60	0.60	0.90
M2.5 X 0.45	5.0	2.00	0.70	1.10
M3 X 0.5	6.0	2.40	1.00	1.30
M3.5 X 0.6	7.0	2.70	1.10	1.40
M4 X 0.7	8.0	3.10	1.20	1.60
M5 X 0.8	9.4	3.80	1.50	2.00
M6 X 1.0	12.0	4.60	1.90	2.30
M8 X 1.25	16.0	6.00	2.30	2.80
M10 X 1.5	20.0	7.50	2.80	3.20

Nominal Screw Length	Tolerance On Length
to 3 mm incl.	0.2
over 3 to 10 mm	0.3
over 10 to 16 mm	0.4
over 16 to 50 mm	0.5
over 50 mm	1.0

All tolerances are plus and minus.



# METRIC SCREWS, BOLTS AND THREADED ROD

SECTION  
**XIII**

ALL DIMENSIONS ARE IN MILLIMETERS

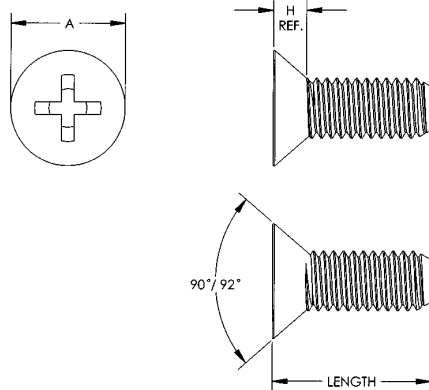

THREAD SIZE	A	* H
M2 X 0.4	3.5 - 4.4	1.2 max ref.
M2.5 X 0.45	4.4 - 5.5	1.5 max ref.
M3 X 0.5	5.2 - 6.3	1.7 max ref.
M3.5 X 0.6	6.9 - 8.2	2.3 max ref.
M4 X 0.7	8.0 - 9.4	2.7 max ref.
M5 X 0.8	8.9 - 10.4	2.7 max ref.
M6 X 1	10.9 - 12.6	3.3 max ref.
M8 X 1.25	15.4 - 17.3	4.6 max ref.
M10 X 1.5	17.8 - 20.0	5.0 max ref.

\* H Dimension is a reference dimension only.

## FLAT PHILLIPS



### ITEM NUMBER ----- DESCRIPTION -----

50M025045I004	M2.5 X .45 X 4MM	Flat Phil
50M025045I005	M2.5 X .45 X 5MM	Flat Phil
50M025045I006	M2.5 X .45 X 6MM	Flat Phil
50M025045I008	M2.5 X .45 X 8MM	Flat Phil
50M025045I010	M2.5 X .45 X 10MM	Flat Phil
50M025045I012	M2.5 X .45 X 12MM	Flat Phil
50M025045I016	M2.5 X .45 X 16MM	Flat Phil
50M025045I020	M2.5 X .45 X 20MM	Flat Phil
50M025045I025	M2.5 X .45 X 25MM	Flat Phil
50M030050I005	M3 X .5 X 5MM	Flat Phil
50M030050I006	M3 X .5 X 6MM	Flat Phil
50M030050I008	M3 X .5 X 8MM	Flat Phil
50M030050I010	M3 X .5 X 10MM	Flat Phil
50M030050I012	M3 X .5 X 12MM	Flat Phil
50M030050I016	M3 X .5 X 16MM	Flat Phil
50M030050I020	M3 X .5 X 20MM	Flat Phil
50M030050I025	M3 X .5 X 25MM	Flat Phil
50M035060I005	M3.5 X .6 X 5MM	Flat Phil
50M035060I006	M3.5 X .6 X 6MM	Flat Phil
50M035060I008	M3.5 X .6 X 8MM	Flat Phil
50M035060I010	M3.5 X .6 X 10MM	Flat Phil
50M035060I012	M3.5 X .6 X 12MM	Flat Phil
50M035060I016	M3.5 X .6 X 16MM	Flat Phil
50M035060I020	M3.5 X .6 X 20MM	Flat Phil
50M035060I025	M3.5 X .6 X 25MM	Flat Phil
50M035060I035	M3.5 X .6 X 35MM	Flat Phil
50M040070I006	M4 X .7 X 6MM	Flat Phil
50M040070I008	M4 X .7 X 8MM	Flat Phil
50M040070I010	M4 X .7 X 10MM	Flat Phil
50M040070I012	M4 X .7 X 12MM	Flat Phil

### ITEM NUMBER ----- DESCRIPTION -----

50M040070I016	M4 X .7 X 16MM	Flat Phil
50M040070I020	M4 X .7 X 20MM	Flat Phil
50M040070I025	M4 X .7 X 25MM	Flat Phil
50M050080I006	M5 X .8 X 6MM	Flat Phil
50M050080I008	M5 X .8 X 8MM	Flat Phil
50M050080I010	M5 X .8 X 10MM	Flat Phil
50M050080I012	M5 X .8 X 12MM	Flat Phil
50M050080I016	M5 X .8 X 16MM	Flat Phil
50M050080I020	M5 X .8 X 20MM	Flat Phil
50M050080I025	M5 X .8 X 25MM	Flat Phil
50M050080I030	M5 X .8 X 30MM	Flat Phil
50M050080I040	M5 X .8 X 40MM	Flat Phil
50M060100I008	M6 X 1.00 X 8MM	Flat Phil
50M060100I010	M6 X 1.00 X 10MM	Flat Phil
50M060100I012	M6 X 1.00 X 12MM	Flat Phil
50M060100I016	M6 X 1.00 X 16MM	Flat Phil
50M060100I020	M6 X 1.00 X 20MM	Flat Phil
50M060100I025	M6 X 1.00 X 25MM	Flat Phil
50M060100I035	M6 X 1.00 X 35MM	Flat Phil
50M060100I045	M6 X 1.00 X 45MM	Flat Phil
50M080125I010	M8 X 1.25 X 10MM	Flat Phil
50M080125I016	M8 X 1.25 X 16MM	Flat Phil
50M080125I020	M8 X 1.25 X 20MM	Flat Phil
50M080125I025	M8 X 1.25 X 25MM	Flat Phil
50M080125I030	M8 X 1.25 X 30MM	Flat Phil
50M080125I050	M8 X 1.25 X 50MM	Flat Phil
50M100150I020	M10 X 1.50 X 20MM	Flat Phil
50M100150I025	M10 X 1.50 X 25MM	Flat Phil
50M100150I035	M10 X 1.50 X 35MM	Flat Phil

Nominal Screw Length	Tolerance On Length
to 3 mm incl.	0.2
over 3 to 10 mm	0.3
over 10 to 16 mm	0.4
over 16 to 50 mm	0.5
over 50 mm	1.0

All tolerances are plus and minus.



# METRIC SCREWS, BOLTS AND THREADED ROD

ALL DIMENSIONS ARE IN MILLIMETERS

SECTION  
**XIII**

THREAD SIZE	A	H	J	T
M2 X 0.4	3.5 - 4.4	1.2 max ref.	0.5 - 0.7	0.4 - 0.6
M2.5 X 0.45	4.4 - 5.5	1.5 max ref.	0.6 - 0.8	0.5 - 0.7
M3 X 0.5	5.2 - 6.3	1.7 max ref.	0.8 - 1.0	0.6 - 0.9
M3.5 X 0.6	6.9 - 8.2	2.3 max ref.	1.0 - 1.2	0.9 - 1.2
M4 X 0.7	8.0 - 9.4	2.7 max ref.	1.2 - 1.5	1.0 - 1.3
M5 X 0.8	8.9 - 10.4	2.7 max ref.	1.2 - 1.5	1.1 - 1.4
M6 X 1	10.9 - 12.6	3.3 max ref.	1.6 - 1.9	1.2 - 1.6
M8 X 1.25	15.4 - 17.3	4.6 max ref.	2.0 - 2.3	1.8 - 2.3
M10 X 1.5	17.8 - 20.0	5.0 max ref.	2.5 - 2.8	2.0 - 2.6

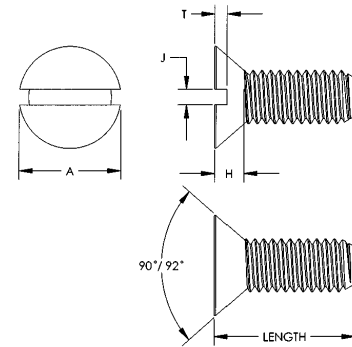

ITEM NUMBER	DESCRIPTION
50M020040H004	M2 X .4 X 4MM Flat Slot
50M020040H005	M2 X .4 X 5MM Flat Slot
50M020040H006	M2 X .4 X 6MM Flat Slot
50M020040H008	M2 X .4 X 8MM Flat Slot
50M020040H010	M2 X .4 X 10MM Flat Slot
50M020040H011	M2 X .4 X 11MM Flat Slot
50M020040H012	M2 X .4 X 12MM Flat Slot
50M020040H016	M2 X .4 X 16MM Flat Slot
50M020040H025	M2 X .4 X 25MM Flat Slot
50M025045H004	M2.5 X .45 X 4MM Flat Slot
50M025045H005	M2.5 X .45 X 5MM Flat Slot
50M025045H006	M2.5 X .45 X 6MM Flat Slot
50M025045H008	M2.5 X .45 X 8MM Flat Slot
50M025045H010	M2.5 X .45 X 10MM Flat Slot
50M025045H012	M2.5 X .45 X 12MM Flat Slot
50M025045H016	M2.5 X .45 X 16MM Flat Slot
50M025045H020	M2.5 X .45 X 20MM Flat Slot
50M025045H025	M2.5 X .45 X 25MM Flat Slot
50M030050H005	M3 X .5 X 5MM Flat Slot
50M030050H006	M3 X .5 X 6MM Flat Slot
50M030050H008	M3 X .5 X 8MM Flat Slot
50M030050H010	M3 X .5 X 10MM Flat Slot
50M030050H012	M3 X .5 X 12MM Flat Slot
50M030050H015	M3 X .5 X 15MM Flat Slot
50M030050H016	M3 X .5 X 16MM Flat Slot
50M030050H020	M3 X .5 X 20MM Flat Slot
50M030050H025	M3 X .5 X 25MM Flat Slot
50M030050H030	M3 X .5 X 30MM Flat Slot
50M030050H042	M3 X .5 X 42MM Flat Slot
50M035060H005	M3.5 X .6 X 5MM Flat Slot
50M035060H006	M3.5 X .6 X 6MM Flat Slot
50M035060H008	M3.5 X .6 X 8MM Flat Slot
50M035060H010	M3.5 X .6 X 10MM Flat Slot
50M035060H016	M3.5 X .6 X 16MM Flat Slot
50M035060H025	M3.5 X .6 X 25MM Flat Slot
50M035060H035	M3.5 X .6 X 35MM Flat Slot
50M040070H006	M4 X .7 X 6MM Flat Slot
50M040070H008	M4 X .7 X 8MM Flat Slot

ITEM NUMBER	DESCRIPTION
50M040070H010	M4 X .7 X 10MM Flat Slot
50M040070H012	M4 X .7 X 12MM Flat Slot
50M040070H015	M4 X .7 X 15MM Flat Slot
50M040070H016	M4 X .7 X 16MM Flat Slot
50M040070H020	M4 X .7 X 20MM Flat Slot
50M040070H025	M4 X .7 X 25MM Flat Slot
50M040070H030	M4 X .7 X 30MM Flat Slot
50M040070H035	M4 X .7 X 35MM Flat Slot
50M050080H006	M5 X .8 X 6MM Flat Slot
50M050080H008	M5 X .8 X 8MM Flat Slot
50M050080H010	M5 X .8 X 10MM Flat Slot
50M050080H012	M5 X .8 X 12MM Flat Slot
50M050080H015	M5 X .8 X 15MM Flat Slot
50M050080H016	M5 X .8 X 16MM Flat Slot
50M050080H020	M5 X .8 X 20MM Flat Slot
50M050080H025	M5 X .8 X 25MM Flat Slot
50M050080H030	M5 X .8 X 30MM Flat Slot
50M050080H040	M5 X .8 X 40MM Flat Slot
50M060100H008	M6 X 1.0 X 8MM Flat Slot
50M060100H010	M6 X 1.0 X 10MM Flat Slot
50M060100H012	M6 X 1.0 X 12MM Flat Slot
50M060100H016	M6 X 1.0 X 16MM Flat Slot
50M060100H020	M6 X 1.0 X 20MM Flat Slot
50M060100H025	M6 X 1.0 X 25MM Flat Slot
50M060100H035	M6 X 1.0 X 35MM Flat Slot
50M060100H040	M6 X 1.0 X 40MM Flat Slot
50M060100H045	M6 X 1.0 X 45MM Flat Slot
50M060100H050	M6 X 1.0 X 50MM Flat Slot
50M080125H016	M8 X 1.25 X 16MM Flat Slot
50M080125H020	M8 X 1.25 X 20MM Flat Slot
50M080125H025	M8 X 1.25 X 25MM Flat Slot
50M080125H030	M8 X 1.25 X 30MM Flat Slot
50M080125H050	M8 X 1.25 X 50MM Flat Slot
50M100150H020	M10 X 1.5 X 20MM Flat Slot
50M100150H025	M10 X 1.5 X 25MM Flat Slot
50M100150H030	M10 X 1.5 X 30MM Flat Slot
50M100150H035	M10 X 1.5 X 35MM Flat Slot
50M100150H060	M10 X 1.5 X 60MM Flat Slot

## FLAT SLOTTED

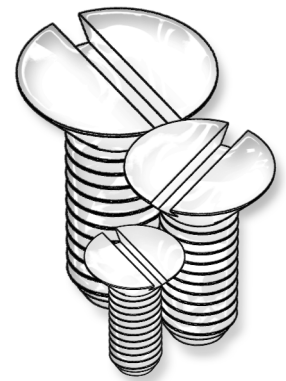

Nominal Screw Length	Tolerance On Length
to 3 mm incl.	0.2
over 3 to 10 mm	0.3
over 10 to 16 mm	0.4
over 16 to 50 mm	0.5
over 50 mm	1.0

All tolerances are plus and minus.



# METRIC SCREWS, BOLTS AND THREADED ROD

SECTION  
**XIII**

ALL DIMENSIONS ARE IN MILLIMETERS

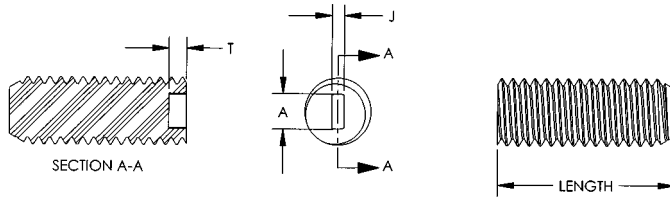

## GRUB SLOTTED



THREAD SIZE	A	J	T
M4 X 0.7	2.0	.64	.76
M5 X 0.8	3.3	.89	1.3
M6 X 1.0	4.1	1.0	1.5
M8 X 1.25	5.2	1.6	2.4
M10 X 1.5	6.6	1.5	2.5

Nominal Screw Length	Tolerance On Length
to 3 mm incl.	0.2
over 3 to 10 mm	0.3
over 10 to 16 mm	0.4
over 16 to 50 mm	0.5
over 50 mm	1.0

All tolerances are plus and minus.

ITEM NUMBER	DESCRIPTION
50M040070R003	M4 X .7 X 3MM Grub Slot
50M040070R004	M4 X .7 X 4MM Grub Slot
50M040070R006	M4 X .7 X 6MM Grub Slot
50M040070R008	M4 X .7 X 8MM Grub Slot
50M040070R010	M4 X .7 X 10MM Grub Slot
50M040070R012	M4 X .7 X 12MM Grub Slot
50M040070R016	M4 X .7 X 16MM Grub Slot
50M040070R020	M4 X .7 X 20MM Grub Slot
50M040070R025	M4 X .7 X 25MM Grub Slot
50M040070R030	M4 X .7 X 30MM Grub Slot
50M040070R035	M4 X .7 X 35MM Grub Slot
50M040070R040	M4 X .7 X 40MM Grub Slot
50M050080R006	M5 X .8 X 6MM Grub Slot
50M050080R008	M5 X .8 X 8MM Grub Slot
50M050080R010	M5 X .8 X 10MM Grub Slot
50M050080R012	M5 X .8 X 12MM Grub Slot
50M050080R016	M5 X .8 X 16MM Grub Slot
50M050080R020	M5 X .8 X 20MM Grub Slot
50M050080R025	M5 X .8 X 25MM Grub Slot
50M050080R030	M5 X .8 X 30MM Grub Slot
50M050080R040	M5 X .8 X 40MM Grub Slot
50M060100R005	M6 X 1.00 X 5MM Grub Slot
50M060100R008	M6 X 1.00 X 8MM Grub Slot
50M060100R010	M6 X 1.00 X 10MM Grub Slot
50M060100R012	M6 X 1.00 X 12MM Grub Slot
50M060100R016	M6 X 1.00 X 16MM Grub Slot
50M060100R020	M6 X 1.00 X 20MM Grub Slot

ITEM NUMBER	DESCRIPTION
50M060100R022	M6 X 1.00 X 22MM Grub Slot
50M060100R025	M6 X 1.00 X 25MM Grub Slot
50M060100R030	M6 X 1.00 X 30MM Grub Slot
50M060100R035	M6 X 1.00 X 35MM Grub Slot
50M060100R045	M6 X 1.00 X 45MM Grub Slot
50M060100R050	M6 X 1.00 X 50MM Grub Slot
50M060100R060	M6 X 1.00 X 60MM Grub Slot
50M060100R070	M6 X 1.00 X 70MM Grub Slot
50M060100R075	M6 X 1.00 X 75MM Grub Slot
50M080125R008	M8 X 1.25 X 8MM Grub Slot
50M080125R010	M8 X 1.25 X 10MM Grub Slot
50M080125R016	M8 X 1.25 X 16MM Grub Slot
50M080125R020	M8 X 1.25 X 20MM Grub Slot
50M080125R025	M8 X 1.25 X 25MM Grub Slot
50M080125R030	M8 X 1.25 X 30MM Grub Slot
50M080125R035	M8 X 1.25 X 35MM Grub Slot
50M080125R050	M8 X 1.25 X 50MM Grub Slot
50M100150R013	M10 X 1.50 X 13MM Grub Slot
50M100150R016	M10 X 1.50 X 16MM Grub Slot
50M100150R019	M10 X 1.50 X 19MM Grub Slot
50M100150R020	M10 X 1.50 X 20MM Grub Slot
50M100150R025	M10 X 1.50 X 25MM Grub Slot
50M100150R030	M10 X 1.50 X 30MM Grub Slot
50M100150R035	M10 X 1.50 X 35MM Grub Slot
50M100150R050	M10 X 1.50 X 50MM Grub Slot
50M100150R060	M10 X 1.50 X 60MM Grub Slot

## HEX SOCKET HEAD CAP SCREW

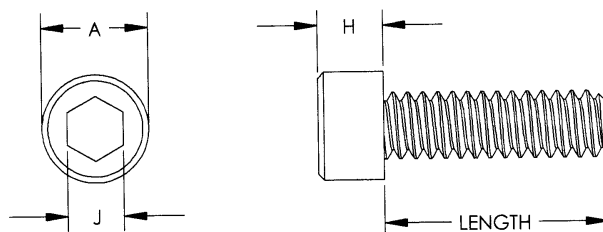
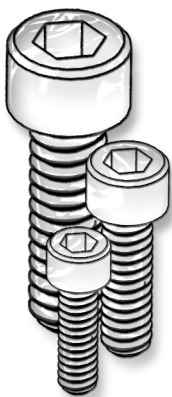

ITEM NUMBER	DESCRIPTION
50M100150S013	M10 X 1.50 X 13MM Hex Soc
50M100150S016	M10 X 1.50 X 16MM Hex Soc
50M100150S019	M10 X 1.50 X 19MM Hex Soc
50M100150S020	M10 X 1.50 X 20MM Hex Soc
50M100150S025	M10 X 1.50 X 25MM Hex Soc
50M100150S030	M10 X 1.50 X 30MM Hex Soc
50M100150S035	M10 X 1.50 X 35MM Hex Soc
50M100150S050	M10 X 1.50 X 50MM Hex Soc
50M100150S060	M10 X 1.50 X 60MM Hex Soc

Nominal Screw Size	M1.6 thru M10	M12 thru M20	Over M20
Nominal Screw Length	Tolerance on Length, mm		
to 16 mm, incl.	0.3	0.3	--
over 16 to 50 mm	0.4	0.4	0.7
over 50 to 120 mm	0.7	1.0	1.5
over 120 to 200mm	1.0	1.5	2.0
over 200 mm	2.0	2.5	3.0

All tolerances are plus and minus.

THREAD SIZE	A	H	J	HEX DEPTH
M 10	15.67 - 16.00	9.81 - 10.00	8.0 nom.	5.00 min.

# METRIC SCREWS, BOLTS AND THREADED ROD

ALL DIMENSIONS ARE IN MILLIMETERS

SECTION  
**XIII**

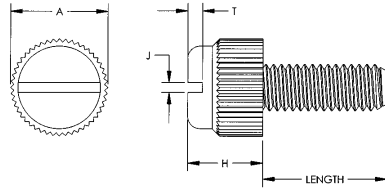
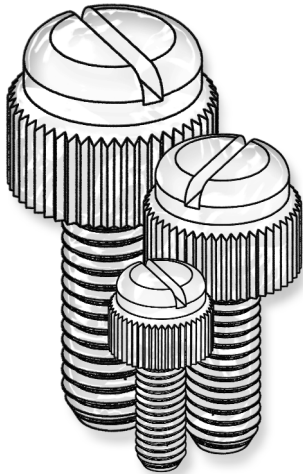

## ECONOMY GRADE THUMB SCREW

A\* +/- .26mm TOLERANCE

Nominal Screw Length	Tolerance On Length	THREAD SIZE				
		H	A*	J	T	
to 3 mm incl.	0.2	M3 X .5	5.2	7.6	1.0	1.1
over 3 to 10 mm	0.3	M3.5 X .6	6.1	8.5	1.1	1.3
over 10 to 16 mm	0.4	M4 X .7	7.1	9.70	.90	1.15
over 16 to 50 mm	0.5	M5 X .8	7.75	10.04	1.02	1.52
over 50 mm	1.0	M6 X 1.0	7.75	12.21	1.14	1.53

All tolerances are plus and minus.

ITEM NUMBER	DESCRIPTION	ITEM NUMBER	DESCRIPTION
50M030050T004	M3 X .5 X 4MM Thumb Screw	50M040070T020	M4 X .7 X 20MM Thumb Screw
50M030050T005	M3 X .5 X 5MM Thumb Screw	50M040070T025	M4 X .7 X 25MM Thumb Screw
50M030050T006	M3 X .5 X 6MM Thumb Screw	50M040070T030	M4 X .7 X 30MM Thumb Screw
50M030050T008	M3 X .5 X 8MM Thumb Screw	50M040070T035	M4 X .7 X 35MM Thumb Screw
50M030050T010	M3 X .5 X 10MM Thumb Screw	50M040070T040	M4 X .7 X 40MM Thumb Screw
50M030050T012	M3 X .5 X 12MM Thumb Screw	50M050080T006	M5 X .8 X 6MM Thumb Screw
50M030050T016	M3 X .5 X 16MM Thumb Screw	50M050080T008	M5 X .8 X 8MM Thumb Screw
50M030050T020	M3 X .5 X 20MM Thumb Screw	50M050080T010	M5 X .8 X 10MM Thumb Screw
50M030050T025	M3 X .5 X 25MM Thumb Screw	50M050080T012	M5 X .8 X 12MM Thumb Screw
50M030050T030	M3 X .5 X 30MM Thumb Screw	50M050080T016	M5 X .8 X 16MM Thumb Screw
50M030050T035	M3 X .5 X 35MM Thumb Screw	50M050080T020	M5 X .8 X 20MM Thumb Screw
50M030050T042	M3 X .5 X 42MM Thumb Screw	50M050080T025	M5 X .8 X 25MM Thumb Screw
50M035060T005	M3.5 X .6 X 5MM Thumb Screw	50M050080T030	M5 X .8 X 30MM Thumb Screw
50M035060T006	M3.5 X .6 X 6MM Thumb Screw	50M050080T040	M5 X .8 X 40MM Thumb Screw
50M035060T008	M3.5 X .6 X 8MM Thumb Screw	50M060100T005	M6 X 1.00 X 5MM Thumb Screw
50M035060T010	M3.5 X .6 X 10MM Thumb Screw	50M060100T008	M6 X 1.00 X 8MM Thumb Screw
50M035060T012	M3.5 X .6 X 12MM Thumb Screw	50M060100T010	M6 X 1.00 X 10MM Thumb Screw
50M035060T016	M3.5 X .6 X 16MM Thumb Screw	50M060100T012	M6 X 1.00 X 12MM Thumb Screw
50M035060T020	M3.5 X .6 X 20MM Thumb Screw	50M060100T016	M6 X 1.00 X 16MM Thumb Screw
50M035060T025	M3.5 X .6 X 25MM Thumb Screw	50M060100T020	M6 X 1.00 X 20MM Thumb Screw
50M035060T035	M3.5 X .6 X 35MM Thumb Screw	50M060100T022	M6 X 1.00 X 22MM Thumb Screw
50M035060T042	M3.5 X .6 X 42MM Thumb Screw	50M060100T025	M6 X 1.00 X 25MM Thumb Screw
50M040070T003	M4 X .7 X 3MM Thumb Screw	50M060100T035	M6 X 1.00 X 35MM Thumb Screw
50M040070T006	M4 X .7 X 6MM Thumb Screw	50M060100T040	M6 X 1.00 X 40MM Thumb Screw
50M040070T008	M4 X .7 X 8MM Thumb Screw	50M060100T045	M6 X 1.00 X 45MM Thumb Screw
50M040070T010	M4 X .7 X 10MM Thumb Screw	50M060100T050	M6 X 1.00 X 50MM Thumb Screw
50M040070T012	M4 X .7 X 12MM Thumb Screw	50M060100T060	M6 X 1.00 X 60MM Thumb Screw
50M040070T016	M4 X .7 X 16MM Thumb Screw	50M060100T070	M6 X 1.00 X 70MM Thumb Screw
		50M060100T075	M6 X 1.00 X 75MM Thumb Screw

# METRIC SCREWS, BOLTS AND THREADED ROD

SECTION  
**XIII**

ALL DIMENSIONS ARE IN MILLIMETERS



This versatile threaded rod stock is easily cut to size, resistant to most chemicals, electrically insulating, non-magnetic, light-weight, low thermal conductivity, vibration and abrasion resistant. Stock length is 1 meter. We can furnish cut to your length with a nominal cutting charge. Other plastic materials can be furnished on special order.

## NYLON THREADED ROD

ITEM NUMBER	DESCRIPTION
38M030050TR	M 3 X .5 THREADED ROD
38M040070TR	M 4 X .7 THREADED ROD
38M050080TR	M 5 X .8 THREADED ROD
38M060100TR	M 6 X 1.0 THREADED ROD
38M080125TR	M 8 X 1.25 THREADED ROD

# METRIC NUTS

SECTION  
**XIV**

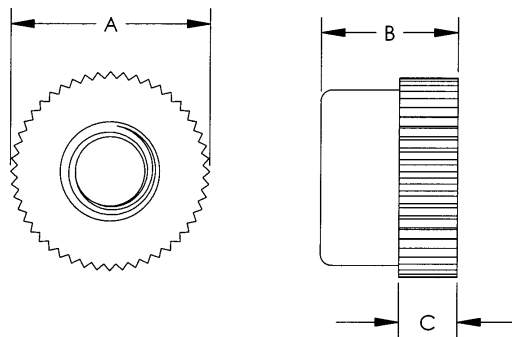

## NYLON THUMB NUTS TOLERANCE +/- .26 mm

ITEM NUMBER	DESCRIPTION	A	B	C
08M040070TN	M4 X 0.7	10.8	7.7	3.5